

Instruction Manual

Flow Measurement Transmitter

NivuFlow Mobile 600 / NivuFlow Mobile 600 Ex



Firmware Revision: 3.4X

Revised manual

Document revision: 04 / 27.05.2020

Original Manual: German / rev. 04 as of 25.05.2020

NIVUS AG, Switzerland

Burgstrasse 28
8750 Glarus, Switzerland
Phone +41 (0)55 6452066
Fax +41 (0)55 6452014
swiss@nivus.com
www.nivus.de

NIVUS Austria

Muehlbergstrasse 33B
3382 Loosdorf, Austria
Phone +43 (2754) 567 63 21
Fax +43 (2754) 567 63 20
austria@nivus.com
www.nivus.de

NIVUS Sp. z o.o., Poland

ul. Hutnicza 3 / B-18
81-212 Gdynia, Poland
Phone +48 (0) 58 7602015
Fax +48 (0) 58 7602014
biuro@nivus.pl
www.nivus.pl

NIVUS France

67870 Bischofsheim, France
Phone +33 (0)3 88 9992 84
info@nivus.fr
www.nivus.fr

NIVUS Ltd., United Kingdom

Wedgewood Rugby Road
Weston under Wetherley
Royal Leamington Spa
CV33 9BW, Warwickshire
Phone +44 (0)8445 3328 83
nivusUK@nivus.com
www.nivus.com

NIVUS Middle East (FZE)

Building Q 1-1 ap. 055
P.O. Box: 9217
Sharjah Airport International
Free Zone
Phone +971 6 55 78 224
Fax +971 6 55 78 225
middle-east@nivus.com
www.nivus.com

NIVUS Korea Co. Ltd.

#2502, M Dong, Technopark IT Center,
32 Song-do-gwa-hak-ro, Yeon-su-gu,
INCHEON, Korea 406-840
Phone +82 32 209 8588
Fax +82 32 209 8590
korea@nivus.com
www.nivus.com

NIVUS Vietnam

21 Pho Duc Chinh, Ba Dinh,
Hanoi, Vietnam
Phone +84 12 0446 7724
vietnam@nivus.com
www.nivus.com

Copyrights and property rights

This document and its contents are proprietary to NIVUS GmbH and are not to be reproduced or copied without the express written permission of NIVUS GmbH.

Violations oblige to compensation.



Important Note

This instruction manual may exclusively - even in parts - be copied or translated in any other way with the express written consent of NIVUS GmbH.

Translation

If the device is sold to a country in the European Economic Area (EEA) this instruction manual must be translated into the language of the country in which the device is to be used.

Should the translated text be unclear, the original instruction manual (German) must be consulted or the NIVUS GmbH contacted for clarification.

Copyright

No part of this publication may be reproduced, transmitted, sold or disclosed without prior permission. Damages will be claimed for violations.

All rights reserved.

Names

The use of general descriptive names, trade names, trade-marks and the like in this manual does not entitle the reader to assume they may be used freely by everyone. They are often protected registered trademarks even if not marked as such.

Document modifications

Rev.	Modifications	Editor in charge	Date
04	Chap. "23.1 Rechargeable Battery Pack" modified; chap. "52.2 Power Adapter/Battery Charger" added; minor changes in text and layout	MoG	27.05.2020
03	Chap. "5 Warranty" added; chap. "18 Specifications" modified; chap. "27 Connecting the Connector Box for Inputs/Outputs": procedure modified; chap. "28 (T-Shape) Antenna for GPRS Data Remote Transmission": Important note added; chap. "36 Parameter Setting using Quick Start": Fig. 36 4 modified; chap. "37.2.7 Menu - Quick Start": Fig. 37 8 modified; Activation of Function Licences, chap. "40.5.5 Feature unlock" modified; chap. "44.3 Menu >Quick Start< / >v-Path 1<": Fig. 44 3 modified; chap. "47 Diagnostics Menu v-Paths": Fig. and text for "Alignment" modified; chap. "53 Dismantling/Disposal" note to "EC WEEE-Directive" modified; chap. "Approvals and Certificates" revised	MoG	17.03.2020
02	Address NIVUS France revised; chap. "1.3.1 Colour code for wires and single conductors", "5 Liability disclaimer", "22.1.3 Operation/Charging via an Alternative Power Supply" modified; chap. "24.3 Overvoltage Protection Measures" added; chap. "26 Connecting the Connector Box for Inputs/Outputs": Fig. 26 2 modified; chap. "29 Indication System of Status LED on NivuFlow Mobile" added; chap. "30 Setting Up Connection": "Session Timeout" removed; chap."31.3 Menus": "Alert" added; chap. "32.2 Programming a 1-path diametrically opposed Measurement", "35 Parameter Setting using Quick Start", "36.2.3 Menu - System", "36.2.7 Menu - Quick Start" changed; chap. "36.2.8 Menu - Alert" added; chap. "37.3.1 Analog Inputs", "37.3.3 Digital Inputs", "39.2.3 Units" and "39.2.4 Data Units" changed; chap. "39.5 Service": "Feature unlock" added; chap. "39.6 Storage Mode", "40 Parameter Menu Communication" and "43 Parameter Menu Quick Start" modified; chap. "44 Parameter Menu Alert" added; chap. "48 Diagnostics Menu Signal Analysis" and "54 Accessories" modified; chap. "Approvals and Certificates" revised; some images revised	MoG	10.07.2019
01	Cover page updated; new firmware version; Ex functions added (concerns various chapters); Ex certificate/EC declarations of conformity added/replaced and according references/images changed; data transmission via GPRS/UMTS/LTE added; structure of chapters modified: "Delivery, Storage and Transport"; chapter revised (contents or warnings): 2.1.2, 2.3, 3.2, 4, 15, 16, 17, 18, 20, 21, 22, 24, 26, 30, 33.5, 35.2.1, 35.2.4, 36.2.1, 36.2.2, 36.3.3, 36.3.4, 37.3, 38.3, 38.5, 38.6, 39 and 52; Chap. "Maintenance and Cleaning" revised; New chapters: "1.3 Abbreviations used", "7 Ex Protection", "27 (T-Shape) Antenna for GPRS Data Remote Transmission" and "Credits and Licenses"; Various minor text corrections; some images revised.	MoG	09.11.2018
00	First version based on the German document	MoG	04.09.2017

Table of contents

<u>Copyrights and property rights</u>	3
<u>Document modifications</u>	4
<u>Table of contents</u>	5
<u>General</u>	10
1 About this manual.....	10
1.1 Applicable documentation.....	10
1.2 Signs and definitions used.....	10
1.3 Abbreviations used.....	11
1.3.1 Colour code for wires and single conductors.....	11
2 Connections and Operating Elements.....	11
2.1 Power Supply.....	11
2.1.1 Transmitter.....	11
2.1.2 Rechargeable Batteries.....	12
2.2 NivuFlow Mobile Operating Elements.....	12
2.3 Interfaces.....	13
<u>Safety Instructions</u>	14
3 Used symbols and signal words.....	14
3.1 Valuation of the accident level.....	14
3.2 Warning notices on the product (option).....	15
4 Safeguards and Precautions.....	15
5 Warranty.....	16
6 Liability disclaimer.....	17
7 Use in accordance with the requirements.....	17
8 Ex Protection.....	18
9 User's Responsibilities.....	19
10 Personnel requirements.....	19
<u>Delivery, Storage and Transport</u>	20
11 Delivery.....	20
12 Reception inspection.....	20
13 Storage.....	21
14 Transport.....	21
15 Return.....	21
<u>Product Specification</u>	22
16 Product Construction and Overview.....	22
16.1 Enclosure Dimensions.....	23
16.2 Connectable Sensors.....	23
17 Device identification.....	23
18 Specifications.....	25
19 Configuration/Device Types.....	26

Functional description	27
20 Operating Ranges	27
21 Functional Principle	27
21.1 Flow Velocity Detection	27
21.2 Flow Calculation	29
Installation and Connection	30
22 General Information on Installation	30
22.1 Installation place	30
22.2 Before Installation	30
22.2.1 PU stickers on enclosure frame	30
22.2.2 Gaskets	30
22.2.3 Securing the Instrument	31
22.2.4 Connection Sockets	31
23 Electrical Installation/Power Supply	31
23.1 Rechargeable Battery Pack	32
23.1.1 Removing/Inserting the Rechargeable Battery Pack	32
23.1.2 Charging the rechargeable battery pack	33
23.1.3 Operation/Charging via an Alternative Power Supply	35
23.1.4 Operation/Charging with direct connection to mains power	36
24 Sensor Installation in General	36
24.1 Sensor Installation Basics	36
24.2 Installation of Clamp-On Sensors	37
24.3 Installation of wet Sensors	38
25 Sensor Connection	39
25.1 Cable for Sensor Connection	39
25.2 Sensor Connection	39
25.3 Overvoltage Protection Measures	40
26 Single external Connection for Inputs/Outputs	41
27 Connecting the Connector Box for Inputs/Outputs	42
28 (T-Shape) Antenna for GPRS Data Remote Transmission	44
Putting into Operation	45
29 Notes to Users	45
30 Indication System of Status LED on NivuFlow Mobile	45
31 Setting Up Connection	46
31.1 General	46
31.2 Android Operating System	46
31.3 iOS Operating System	49
31.4 Windows Operating System	52
32 Menu Operation/Overview	55
32.1 Display Overview	55
32.2 Saving Parameters	56
32.3 Menus	57
Start-Up Examples	58
33 Measurement with Clamp-On Sensors	58
33.1 General	58

33.2	Programming a 1-path diametrically opposed Measurement	58
33.2.1	Simple Parameter Setting	58
33.2.2	Extended Parameter Setting	61
34	Measurement with wet Sensors	61
Parameter Setting		62
35	General Programming	62
35.1	Save Parameters	62
35.2	Change WLAN Password	62
35.3	Change Instrument SSID	63
35.4	Lost Password	63
35.5	Automatic Data Transmission to USB Stick	64
36	Parameter Setting using Quick Start	65
37	Parameter Functions	67
37.1	Main Menu	67
37.2	Functions of the first Menu Level	67
37.2.1	Menu - Application	67
37.2.2	Menu - Data	68
37.2.3	Menu - System	69
37.2.4	Menu - Communication	70
37.2.5	Menu - Display	70
37.2.6	Menu - Battery (12V)	71
37.2.7	Menu - Quick Start	71
37.2.8	Menu - Alert	72
38	Parameters Menu Application	73
38.1	Menu Measure Place	73
38.1.1	Name of Measurement Place	73
38.1.2	Transit Time Mode	74
38.1.3	Number of Paths	74
38.1.4	Medium	75
38.1.5	Medium Temperature	75
38.1.6	Channel Profiles	75
38.1.7	Wall Material	76
38.1.8	Lining	77
38.1.9	Sludge Level	77
38.1.10	Low-Flow Suppression	77
38.1.11	Damping	77
38.1.12	Stability	78
38.2	Menu v-Paths	78
38.2.1	Sensor Types in >Clamp-On< Transit Time Mode	78
38.2.2	Sensor Types in >Wet< Transit Time Mode	79
38.2.3	Sensor Mounting Position	79
38.2.4	v-Minimum and v-Maximum	80
38.3	Menu Inputs/Outputs (analog and digital)	80
38.3.1	Analog Inputs	80
38.3.2	Analog Outputs	81
38.3.3	Digital Inputs	83
38.3.4	Digital Outputs	84
38.4	Diagnostics Menu	85
39	Parameter Menu Data	85
39.1	Trend	86

39.2	Day Totals	87
39.3	Data Memory.....	89
40	Parameter Menu System	91
40.1	Information	91
40.2	Region Settings.....	91
40.2.1	(Operation) Language.....	92
40.2.2	Date Format	92
40.2.3	Units	92
40.2.4	Data Units	93
40.3	Time/Date.....	94
40.4	Error Messages.....	95
40.5	Service	95
40.5.1	Service Level.....	96
40.5.2	Restart.....	96
40.5.3	Powerdown	96
40.5.4	Parameter Reset.....	96
40.5.5	Feature unlock	97
40.5.6	Update NivuFlow.....	99
40.5.7	Update Bootloader	99
40.6	Storage Mode.....	100
41	Parameter Menu Communication	102
42	Parameter Menu Display.....	107
43	Parameter Menu Battery (12V)	108
44	Parameter Menu Quick Start.....	109
44.1	Menu >Quick Start< / >Region Settings<	109
44.2	Menu >Quick Start< / >Measure Place<.....	110
44.3	Menu >Quick Start< / >v-Path 1<	110
44.4	Menu >Quick Start< / >Analog Input 1<.....	111
44.5	Menu >Quick Start< / >Digital Input 1<.....	111
45	Parameter Menu Alert	112
45.1	Menu >Alert< / >Flow<.....	112
45.2	Menu >Alert< / >Velocity<.....	113
45.3	Menu >Alert< / >Water temperature<	114
45.4	Menu >Alert< / >Battery (12V)<	115
45.5	Menu >Alert< / >Analog Input 1<	115
45.6	Menu >Alert< / >Analog Input 2<	116
45.7	Menu >Alert< / >Analog Input 3<	117
45.8	Menu >Alert< / >Digital Input<	118
Diagnostics		119
46	Diagnostics Menu Principles.....	119
47	Diagnostics Menu v-Paths	120
48	Diagnostics Menu Inputs and Outputs	121
48.1	Important Information on the Simulation	121
49	Diagnostics Menu Signal Analysis	123
50	Simulation.....	128

<u>Maintenance and Cleaning</u>	129
51 Maintenance.....	129
51.1 Maintenance Interval.....	129
51.2 Customer Service Information	130
52 Cleaning	130
52.1 Transmitter	130
52.2 Power Adapter/Battery Charger	130
52.3 Sensors	130
53 Dismantling/Disposal.....	131
54 Installation of spare parts and parts subject to wear and tear	131
55 Accessories	131
<u>Index</u>	133
<u>Credits and Licenses</u>	136
56 List of references of the licenses and codes used	136
<u>Approvals and Certificates</u>	137

General

1 About this manual



Important note

READ CAREFULLY BEFORE USE.

KEEP IN A SAFE PLACE FOR LATER REFERENCE.

This instruction manual is for the intended use of the flow measurement transmitter NivuFlow Mobile 600. This manual is oriented exclusively to qualified expert personnel.

Read this instruction manual carefully and completely prior to installation and connection since it contains relevant information on this product. Observe the notes and particularly follow the warning notes and safety instructions.

If you should have problems to understand information contained within this instruction manual either contact the NIVUS GmbH or one of the distributors for further support. The legally associated companies and subsidiaries of NIVUS group cannot be held responsible for damage to persons or material due to incorrectly understood information in this instruction.

1.1 Applicable documentation

For the installation and operation of the complete system extra instruction manuals or technical descriptions may be required apart from this manual.

- Technical Instruction for Transit Time Sensors
- Installation Instruction for Transit Time Sensors

These manuals are provided with the auxiliary units or sensors and/or are available as download on the NIVUS homepage.

1.2 Signs and definitions used



Image	Meaning	Remark
	(Action) Step	Action to be performed by you. Note the numbering of action steps. Observe the order of the working steps.
	Cross-reference	Refers to further or detailed information.
>Text<	Parameter or Menu	Indicates a parameter or a menu that is selected or described.
	Reference to document	Refers to an accompanying documentation.

Table 1 Structural elements within the manual

1.3 Abbreviations used

1.3.1 Colour code for wires and single conductors

The abbreviations of colours, wire and components follow the international colour code according IEC 60757.

BK	black	BN	brown	RD	red
OG	orange	YE	yellow	GN	green
BU	blue	VT	violet	GY	grey
WH	white	PK	pink	TQ	turquoise
GNYE	green/yellow	GD	gold	SR	silver

2 Connections and Operating Elements

2.1 Power Supply

2.1.1 Transmitter

The NivuFlow Mobile (Fig. 2-1 no. 1) is supplied by rechargeable battery packs. Once plugged in the batteries are connected to the transmitter via the charging pins (Fig. 2-1 no. 4) supplying the required operating voltage.

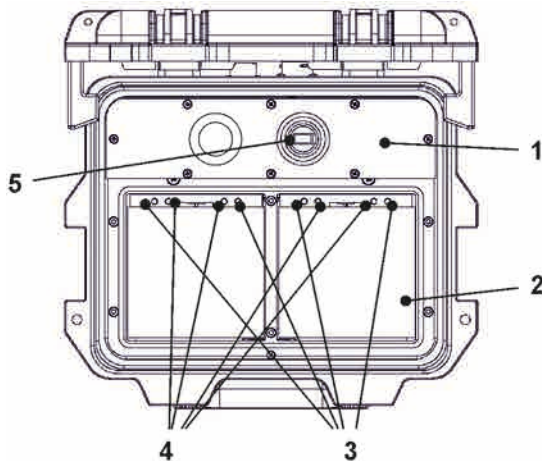

- 1 Transmitter
- 2 Battery compartment (two battery packs; illustration without batteries)
- 3 Guide pins for battery packs
- 4 Charging pins for AC power supply of transmitter
- 5 USB-A interface

Fig. 2-1 Power supply by battery packs (top view)

2.1.2 Rechargeable Batteries

The rechargeable batteries can be charged either in installed condition or while removed by using a battery charger (optional accessory).

WARNING



Risk of explosion when charging battery packs in Ex areas

Charge rechargeable battery packs outside of Ex areas only. Do not charge within Ex areas.

There are two different options to charge the batteries while being installed:

- Power adapter 110...230 V AC using the multifunction socket (Fig. 2-2 no. 1) on the reverse side of the enclosure
- External power source 12...14 V DC (z. B. battery, solar module, fuel cell etc.) using cable via multifunction socket

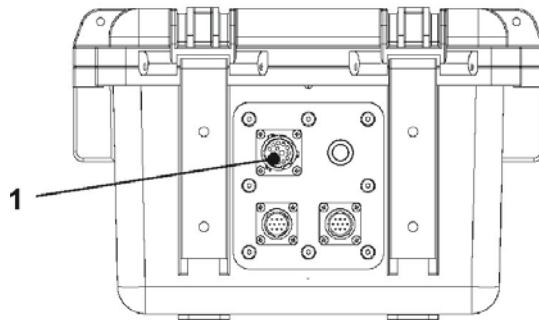

1 Multifunction socket

Fig. 2-2 Charging batteries via multifunction socket



Sensor wiring diagrams can be found in chapter "25 Sensor Connection".

2.2 NivuFlow Mobile Operating Elements

NivuFlow Mobile itself has no direct operating elements. Instrument operation and the setting of parameters are carried out completely by using smartphone, tablet, notebook and PC.

Use here the PC mouse or the touchscreen.



Also refer to the instruction manuals of your preferred smartphone, tablet, notebook or PC.

2.3 Interfaces

The transmitter is equipped with various interfaces which can be found on the reverse side or on the top of the instrument.

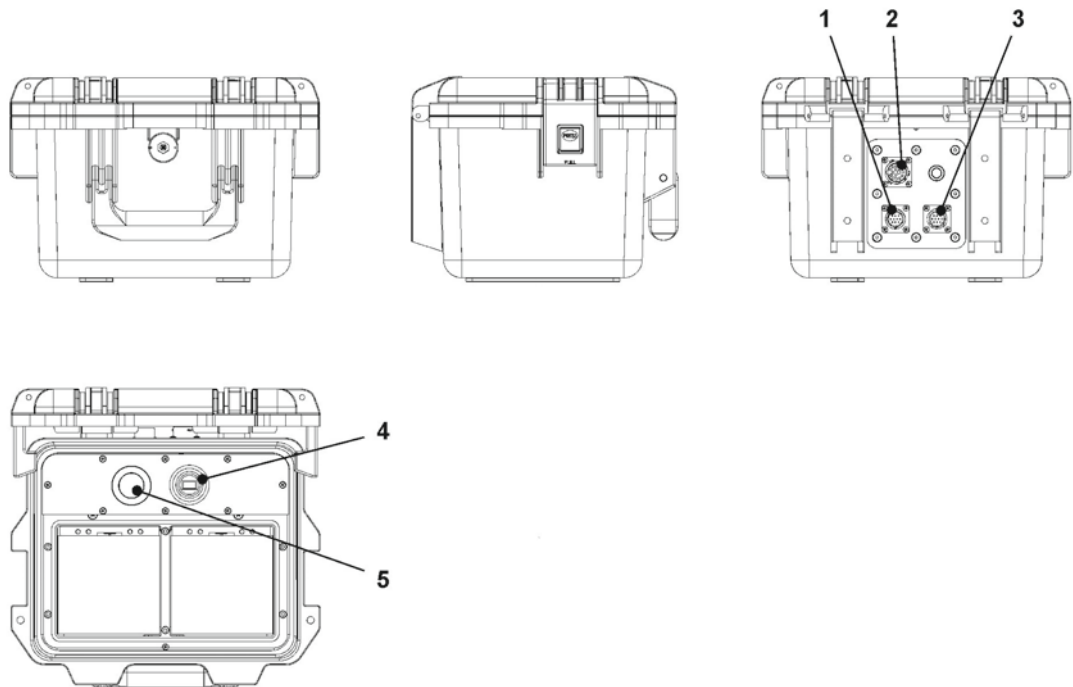

- 1 Sensor socket v2/h
- 2 Multifunction socket I/O
- 3 Sensor socket v1
- 4 USB-A interface (accessible with open cover)
- 5 GPRS SIM card slot (in connection with GPRS antenna)

Fig. 2-3 Available interfaces

Safety Instructions

3 Used symbols and signal words

3.1 Valuation of the accident level



The general warning symbol indicates the risk of personal injuries or death. In the text section the general warning symbol is used in conjunction with the signal words described below.

DANGER

Warnings in high degree of risk



Indicates a high-risk, **imminently** hazardous situation which will result in death or serious injury if not avoided.

WARNING

Warnings in medium degree of risk



Indicates a **possible** danger with medium risk which may result in a life-threatening situation or (severe) bodily injury if it is not avoided.

CAUTION

Warnings in low-risk or property damages



Indicates a possible danger with moderate risk which may result in minor or moderate personal injury or material damage if not avoided.

WARNING

Danger by electric voltage



Indicates a hazard with a high risk of electric shock which may result in a life-threatening situation or (severe) bodily injury if it is not avoided.



Important Note

Contains information that should be highlighted. Indicates a potentially damaging situation which can result in a damage of the product or an object in its environment.



Note

Contains information and facts.

3.2 Warning notices on the product (option)



General warning label

This symbol is for operators to refer to this instruction manual. Observing the information contained therein is required in order to maintain protection measures provided by the instrument during installation procedures and operation.



Protective conductor

This symbol refers to the protective conductor of the unit. Depending on the mode of installation the instrument shall be operated solely connected to an appropriate protective conductor according to applicable laws and regulations.

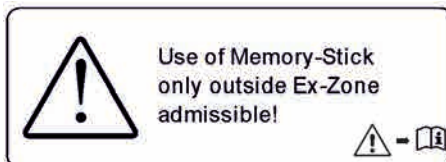
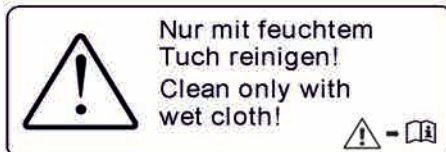
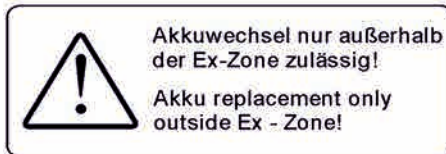

4 Safeguards and Precautions

Working with NIVUS instruments requires to observe and to follow the safety measures and precautions below generally and at any time. These notes and warnings will not be repeated for each description within the document.

WARNING



Check danger through explosive gases

Prior to beginning mounting, installation and maintenance make sure to observe any regulations on safety at work as well as to check the potential risk due to explosive gases. Use a gas warner to check.

When working in the channel system make sure to avoid electrostatic charge:

- Avoid unnecessary movements to minimise the risk of static energy accumulating.
- Discharge any possible static electricity from your body before you begin to install sensors.

Disregarding may lead to personal injury or damage your equipment.

WARNING**Germ contamination**

Please note that due to the operation in the waste water field the measurement system and cables may be loaded with dangerous disease germs. Respective precautionary measures must be taken to avoid damage to one's health.

Wear protective clothing.

WARNING**Observe occupational safety regulations**

Before starting installation work, observing the work safety regulations need to be checked.

Disregarding may lead in personal injury.

WARNING**Do not disable safety devices**

It is strictly prohibited to disable the safety devices or to change the way they work.

Disregarding may lead in personal injury.

WARNING**Disconnect the systems from mains**

Maintenance, cleaning and/or repairs (by qualified personnel only) may only be performed when de-energised.

Disregarding may lead to electric shocks.

**Putting into operation by trained experts only**

The entire measurement system shall be installed and put into operation by trained expert personnel only.

Integrated buffer battery

The exchange of the integrated buffer battery shall be carried out by NIVUS staff or personnel authorised by NIVUS only. Otherwise the guarantee expires.

5 Warranty

The device has been functionally tested before delivery. If it is used as intended (see chapter "7 Use in accordance with the requirements") and the operating instructions, the applicable documents (see chapter "1.1 Applicable documentation") and the safety notes and instructions contained therein, are observed, no functional restrictions are to be expected and perfect operation should be possible.



Please also note in this regard the next chapter "6 Liability disclaimer".

**Limitation of warranty**

In the event of non-compliance with the safety instructions and instructions in this document, the companies of the NIVUS group of companies reserve the right to limit the warranty.

6 Liability disclaimer

The legally associated companies and subsidiaries of NIVUS group assume no liability

- for damages owing to a **change** of this document. The legally associated companies and subsidiaries of the NIVUS group reserve the right to change the contents of this document and this disclaimer at any time and without any notice.
- for damages to persons or objects resulting from **failure to comply** with applicable **regulations**. For connection, commissioning and operation of the sensors all available information and higher local legal regulations (in Germany e.g. VDE regulations) such as applicable Ex regulations as well as safety requirements and regulations in order to avoid accidents shall be adhered to.
- for damages to persons or objects resulting from **improper use**. For safety and warranty reasons, all internal work on the instruments beyond from that involved in normal installation and connection, must be carried out only by qualified NIVUS personnel or persons or companies authorised by NIVUS.
- for damages to persons or objects resulting from the use of instruments in technically **imperfect** condition.
- for damages to persons or objects resulting from the use of instruments **not in accordance with the requirements**.
- for damages to persons or objects resulting from failure to comply with **safety information** contained within this instruction manual.
- for missing or incorrect measurement values or resulting consequential damages due to **improper installation**.

7 Use in accordance with the requirements



Note

The instrument is intended solely for the purpose described below. Modifying or using the instruments for any other purposes without the written consent of the legally associated companies and/or subsidiaries of NIVUS group will not be considered as use in accordance with the requirements.

The legally associated companies and subsidiaries of NIVUS group cannot be held responsible for any damage resulting from improper use.

The user alone bears any risk.

The NivuFlow Mobile 600 transmitter incl. the accompanying sensors is designed for temporary flow measurement of slightly polluted to clear and clean water or equivalent media in full pipes and canals.

NivuFlow Mobile 600 is designed and manufactured in accordance with the current state of the art and with the recognised safety rules and regulations applicable at the time this document is issued. Danger to persons or material damage cannot be completely ruled out, however.

The maximum permissible limit values as specified in chapter “18 Specifications” shall be necessarily observed. Any case varying from these conditions which is not approved by NIVUS GmbH in written form is left at the owner’s risk.



8 Ex Protection

The portable transmitter NivuFlow Mobile 600 and the accompanying sensors are designed to be used in areas with explosive atmospheres (zone 1).

The following conditions must be observed:

- Programming the unit under Ex conditions is permissible:
 - with the programming person **within** the Ex area as soon as the indicator and operating unit used has **an** Ex approval;
 - with the programming person **outside** of the Ex area as soon as the indicator and operating unit used has **no** Ex approval.
- Maintenance and repairs shall be executed only **outside** of Ex area.
- Rechargeable batteries shall be removed/inserted and charged only **outside** of Ex areas.
- In general, only rechargeable batteries approved by NIVUS shall be used **within** Ex areas.
- Use the USB interface only **outside** of Ex areas.
- Replace the SIM card only **outside** of Ex areas.
- The instrument shall be (after successful installation at the measurement place) secured against unauthorised opening by using a padlock (holes on the side of the enclosure).

Approval

Transmitter		II 2G Ex eb ib [ib] mb IIB T4 Gb (TÜV 17 ATEX 196722 X)
Sensors		II 2G Ex ib IIB T4 Gb (TÜV 12 ATEX 087812)



Validity of Ex Approval

The Ex approval is only valid in connection with the respective indication on the transmitter or the sensor nameplate.



Declarations of Conformity and Test Reports

For installation and commissioning the EC Declarations of Conformity and Test Reports of the respective authorities shall be strictly followed.



Ex Approval for Sensors

The Ex approval for the sensors is part of the Technical Description for Transit Time Sensors.

9 User's Responsibilities



Important Note

*In the EEA (European Economic Area) national implementation of the framework directive 89/391/EEC and corresponding individual directives, in particular the directive 2009/104/EC concerning the minimum safety and health requirements for the use of work equipment by workers at work, as amended, are to be observed and adhered to.
In Germany e.g. the Industrial Safety Ordinance must be observed.*

Make sure to have a local operating permit available and observe the associated conditions. In addition to this you must observe environmental requirements and local laws on the following points:

- Personnel safety (accident prevention regulations)
- Safety of work materials and tools (safety equipment and maintenance)
- Disposal of products (laws on wastes)
- Disposal of materials (laws on wastes)
- Cleaning (cleansing agents and disposal)

Connections

Operators shall make sure prior to operating the instrument that during installation and initial start-up the local regulations (such as regulations for electrical connection) are observed.

Keep the manual

Keep this manual in a safe place and make sure it is available for the users of this product at any time.

Provide the manual

In case of selling the instrument this instruction manual shall be provided to the purchaser since it is a part of the standard delivery.

10 Personnel requirements

Installation, commissioning and maintenance shall be executed only by personnel meeting the demands as follows:

- Expert personnel with relevant training and appropriate qualification
- Personnel authorised by the plant operator



Qualified personnel

within the context of this documentation or the safety notes on the product itself are persons who are sufficiently familiar with installation, mounting, starting up and operation of the product and who have the relevant qualifications for their work; for example:

- I. Training, instruction or authorisation to activate/deactivate, isolate, ground, and mark electric circuits and devices/systems according to the safety engineering standards.*
- II. Education and instruction according to the standards of safety engineering regarding the maintenance and use of adequate safety equipment.*
- III. First aid training.*

Delivery, Storage and Transport

11 Delivery

The standard delivery of the NivuFlow Mobile 600 basically contains:

- Transmitter type NivuFlow Mobile 600 (according to shipping documents)
- Ring magnet (solenoid)
- USB stick
- Screw driver for hexagon socket screws
- PU stickers (two pieces: 31x17x3.5 mm) to avoid vacuum in the enclosure in case of being returned (via airfreight) to NIVUS (e.g. for maintenance)
- T-shape antenna (only for versions with internal GPRS / UMTS / LTE modem)
- Padlock (only for Ex versions)
- Instruction manual (incl. certificates of conformity) containing any relevant information on how to operate the NivuFlow

Check extra accessories depending on your order and by using the delivery note.

12 Reception inspection

Check the packaging for visible damage immediately after receipt. Any possible damage in transit shall be instantly reported to the carrier. Furthermore a written report shall be sent to NIVUS GmbH in Eppingen.

Incomplete deliveries shall be reported in writing either to your local representative or directly to the NIVUS head office in Eppingen within two weeks.



Important note

Mistakes cannot be rectified later!

➡ Prior to the first use:

1. Open enclosure cover.
2. Remove both PU stickers (two pieces; 31x17x3.5 mm), if available, from the left and right enclosure frame (Fig. 15-1 no. 1). The stickers have been attached prior to shipping (via airfreight) to prevent the enclosure from getting closed and to avoid vacuum formation due to extreme temperature changes during shipping.

13 Storage

The permissible maximum values regarding ambient conditions such as temperature and humidity according to chapter "18 Specifications" shall be necessarily observed.

Protect the NivuFlow Mobile from corrosive or organic solvent vapours, radioactive radiation as well as strong electromagnetic radiation.



To store the instrument:

1. Remove the batteries.
2. If the hoop guards should be mounted to attach the Connector Box remove the guards (lack of space) and attach the rubber buffers instead.



Rubber buffers

Necessarily attach the rubber buffers

- *to prevent the hidden fastening plates on the reverse side of the NFM in the screw channel from getting lost. The fastening plates are essential since they provide the threads to fasten the hoop guards and additionally stabilise the guards on the NFM;*
- *because the buffers are designed as impact protection for NFM connections and protect the sockets etc. from being damaged.*

14 Transport

Take precautionary measures and use lashing straps or similar to protect the NivuFlow from heavy shocks or vibrations.

15 Return

In case of a required reshipment return the unit at customer cost to NIVUS GmbH in Eppingen using the original packaging.

Insufficiently franked shipments will not be accepted!



Prior to shipping (via airfreight):

1. Attach PU stickers (two pieces; 31x17x3.5 mm) right and left on the enclosure frame (Fig. 15-1 no. 1). This prevents the enclosure from getting closed and eliminates vacuum formation due to extreme temperature changes.
2. Place the NivuFlow Mobile safely in the original packaging for transport.

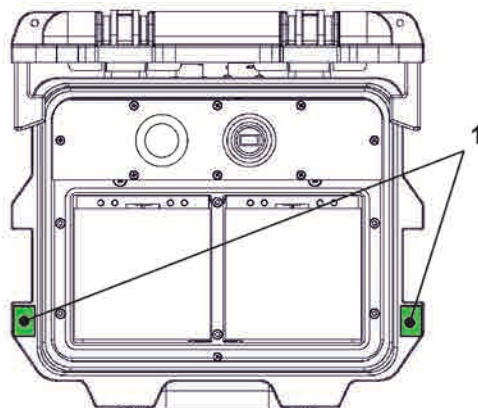
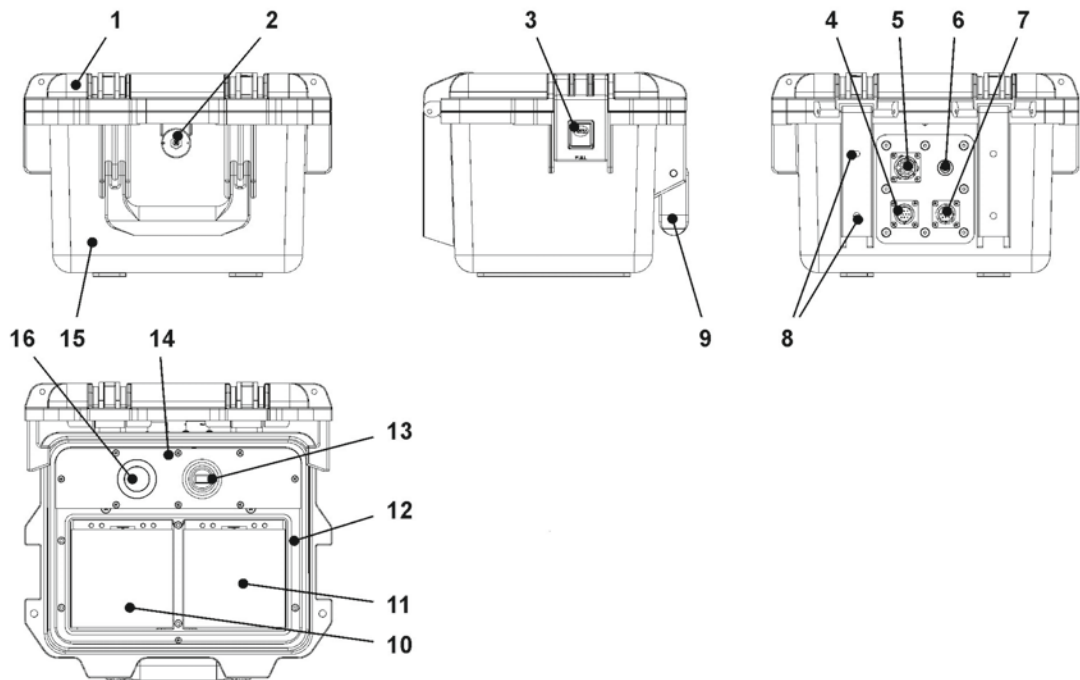

Fig. 15-1 Attachment position for PU stickers

Product Specification

16 Product Construction and Overview



- 1 Enclosure cover
- 2 LED (status indication) and reed contact (wake-up using solenoid)
- 3 Lock (both sides)
- 4 Sensor socket v2/h
- 5 Multifunction socket I/O
- 6 GPRS antenna socket
- 7 Sensor socket v1
- 8 Fastening holes for rubber buffers or hoop guards
- 9 Handle
- 10 Left battery pack receptacle
- 11 Right battery pack receptacle (position to charge the battery)
- 12 Cover (not shown) above batteries with six non-detachable hexagon socket screws
- 13 USB-A interface
- 14 NivuFlow Mobile 600 transmitter (IP67)
- 15 Enclosure (IP68 with cover closed)
- 16 GPRS SIM card slot (in connection with GPRS antenna)

Fig. 16-1 Device construction NivuFlow Mobile 600 with enclosure

16.1 Enclosure Dimensions

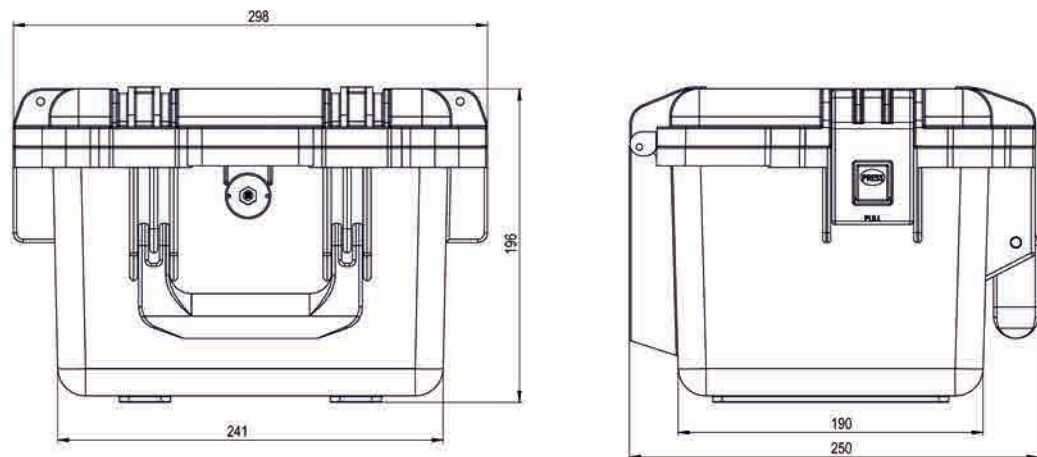

Fig. 16-2 Enclosure

16.2 Connectable Sensors

The photo below provides an overview on the connectable sensors.



- 1 Clamp-on sensor pair type NIC-CO01
- 2 Pipe sensor TSP0 V200 RL0

Fig. 16-3 Connectable sensors overview

17 Device identification

The instructions contained within this manual are valid only for the type of device specified on the title page. The nameplates are fixed on the side of the enclosure and contain the following:

- Name and address of NIVUS GmbH
- CE label
- Information on type and series incl. article and series number
- Year of manufacture: the first four digits of the serial number represent the year and the week number of manufacture (1925.....)
- Ex protection label
- Environmental conditions in operation

In case of enquiries and ordering replacement parts it is important to specify article number as well as the serial number of the respective transmitter or sensor. This ensures correct and quick processing.



Fig. 17-1 Nameplate NivuFlow Mobile 600 (Example Ex-Version)

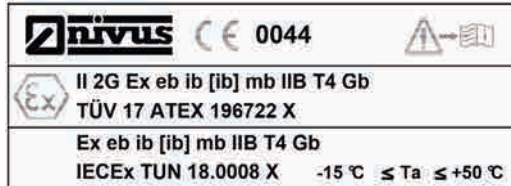

Fig. 17-2 Nameplate NivuFlow Mobile 600 Ex-Version (additionally)



Check nameplates

Check the delivered instrument for accordance with your order by identifying the nameplate.



The declarations of conformity and the EU-Type Examination Certificate are located at the end of the manual.

18 Specifications

Measurement principle	Ultrasonic transit time (time of flight)
Power supply	- 1...2x rechargeable batteries 12 V / 15 Ah, VRLA-AGM - Battery charger 100...240 V AC / 50...60 Hz / 50 VA
Enclosure	- Material: HPX high performance synthetic resin - Weight: approx. 4.7 kg (without batteries and hoop guards) - Protection: IP68 closed / IP67 open
Ex approvals/ other approvals	- ATEX: TÜV 17 ATEX 196722 X - IECEx: TUN18.0008X
Operating temperature	-15 °C...+50 °C
Storage temperature	-15 °C...+70 °C
Max. humidity	90 %, non-condensing
Display	Status LED (RGB)
Operation	Solenoid switch; via WLAN with display and operating module (smartphone, tablet, notebook etc.)
Inputs	- 2x 0/4...20 mA (active/passive) - 1x 0/4...20 mA (passive) - 1x active digital input - 1x socket for power adapter or alternative power supply
Outputs	- 1x analog output 0...10 V - 1x potential-free digital output as SPDT / bistable - 1x USB-A for readout of measurement values via USB stick
Storage cycle	1 min. to 60 min., time-cyclic or event-based 5 sec. to 60 min., continuous
Data memory	Internal; 182,398 measurement cycles
Data transmission/ communication	- via plug-in USB stick - via WLAN - option: via GPRS / UMTS / LTE (integrated modem)

Table 2 Specifications

Sensors

Construction and description of the according sensors as well as the specifications can be found in the according instruction manuals or technical descriptions.

19 Configuration/Device Types

The portable measurement transmitter is available in different versions as shown in the overview table below.

From the article number the type of device can be specified.

NFM-	Design	
	06000	Portable flow measurement transmitter for full pipelines
	000	Standard device
	E00	With ATEX approval Zone 1
	0600G	Portable flow measurement transmitter for full pipelines with data remote transmission
	0E0	With internal modem board Europe (EC21-E) ^{*1}
	0G0	With internal modem board Global (EG25-G) ^{*2}
	0EG	With internal modem board Europe (EC21-E) ^{*1} With Global-wide SIM card
	EE0	With ATEX approval Zone 1 With internal modem board Europe (EC21-E) ^{*1}
	EG0	With ATEX approval Zone 1 With internal modem board Global (EG25-G) ^{*2}
	EEG	With ATEX approval Zone 1 With internal modem board Europe (EC21-E) ^{*1} With Global-wide SIM card
NFM-		

^{*1} Area of operations: Europe, Middle East, Africa, Korea, Thailand, India, Sri Lanka

^{*2} Area of operations: Global

Table 3 Product structure NFM 600



Accessories see chapter "55 Accessories".

Functional description

20 Operating Ranges

The NivuFlow Mobile 600 is a portable measurement system for flow measurement. The instrument is designed mainly for measurement in slightly polluted to clear aqueous media of various compositions.

It is used in full pipes and rectangular geometries with different dimensions.

NivuFlow Mobile 600 with clamp-on sensors is a contactless measurement system and hence is independent from pressure. Clamp-on measurement systems are suitable only for full pipes.

An overview on connectable sensors can be found in chapter "16.2 Connectable Sensors". Using multiple sensor pairs in a common measurement place will increase the accuracy of flow velocity detection.



Note on the measurement method

The measurement method used to determine the flow velocity is based on the transit time difference principle. It is indispensable for the system functionality to have as little interfering particles (dirt particles, gas bubbles and similar) as possible within the medium. Such particles scatter or damp the ultrasonic signal and hence may possibly prevent the measurement.

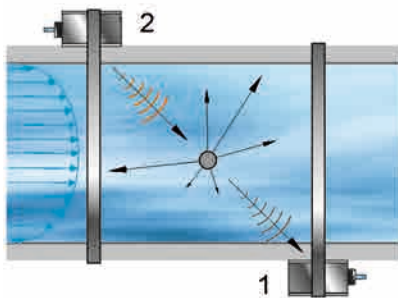
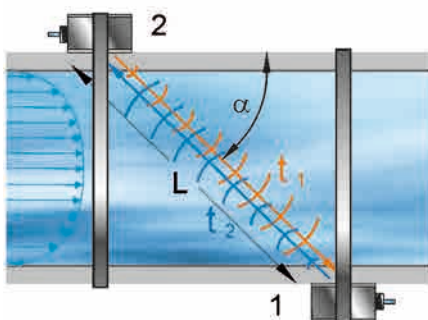

Fig. 20-1 Signal damping due to interfering particles

21 Functional Principle

21.1 Flow Velocity Detection

The flow velocity is determined by using the ultrasonic transit time principle.



- 1 Sensor 1
- 2 Sensor 2
- α Defined angle

t_1	Time of impulse towards flow direction
t_2	Time of impulse in flow direction
L	Transit time

Fig. 21-1 One-path transit time measurement principle

This measurement principle is based on directly measuring the transit time of acoustic signals between two ultrasonic sensors, the so-called hydro-acoustic converters.

The transit time difference method does not determine the average flow velocity, but the effective velocity of sound propagation upstream (decelerated due to flow) and downstream (accelerated due to flow).

Two sound impulses are transmitted consecutively and the different transit times between transmitter and receiver are measured.

- The upstream impulse requires a certain amount of time t_1
- The downstream impulse requires a shorter amount of time t_2

Sound heading downstream will reach the receiver within a shorter period than sound heading upstream. The difference between the transit times is proportional to the average flow velocity within the measurement path.

There is no transit time difference as soon as both sensors receive the transmitted ultrasonic impulses simultaneously. There is no measurable flow available.

The NivuFlow Mobile 600 operates both using clamp-on sensors as well as wet sensors. The clamp-on sensors are installed on the outside of the pipe. In this case the transit time through the pipe wall is calculated and considered.

In order to determine the flow rate, the cross section as well as the flow geometry of the pipe, the canal or the water body must be known. The propagation of sound will either be decelerated (upstream) or accelerated (downstream) depending on the flow direction of the medium.

The transit time difference can be approximated if:

- the main flow direction is known and
- $C \gg v_{1-2}$ is assumed

Here the formula below is used:

$$\Delta t = \frac{2l_{1-2} \cdot v_{1-2}}{c^2}$$

assumed:

- L_{1-2} = length of acoustic measurement path between sensors 1 and 2
- C = speed of sound within water
- v_{1-2} = average flow velocity between sensors 1 and 2 along the measurement path

The more paths are used for transit time measurement and the more paths are used to cover the wetted cross section, the higher the accuracy of the flow measurement.

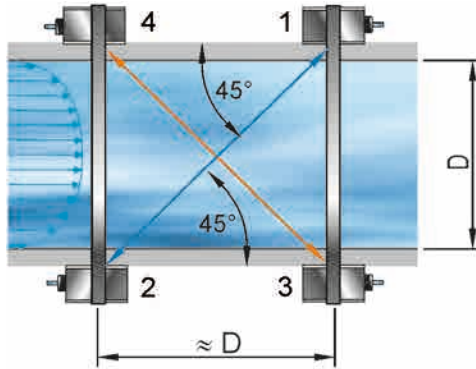

- 1 Sensor 1, path 1
- 2 Sensor 2, path 1
- 3 Sensor 1, path 2
- 4 Sensor 2, path 2
- D Pipe diameter (at sensor installation in an angle of 45°)

Fig. 21-2 Two-path transit time measurement principle

If the sensors are installed in an angle of 45° the distance between sensors 1 and 2 or sensors 3 and 4 is equal to the inside pipe diameter.

If used in multi-path set-ups the angle of deviation “α” of the flow direction can be determined additionally by assuming identical flow velocities.

This angle can be calculated by comparing the measurement results from the individual paths.

21.2 Flow Calculation

In case of using single-path or multi-path installations in one level under the condition

$$Q = v_{average} \cdot A$$

given

- $v_{average}$ = average flow velocity
- A = cross-sectional flow area

It is required to involve a velocity coefficient “k” to compensate the difference between the measured velocity v_g and the average velocity $v_{average}$ within the cross-sectional area.

$$k = \frac{v_{average}}{v_g}$$

Then the flow rate can be calculated by using the signal transit time as follows:

$$Q = k \cdot A \cdot v_g = k \cdot A \cdot \frac{L_{1-2}}{2 \cdot \cos \phi_{1-2}} \cdot \left(\frac{1}{t_{2-1}} - \frac{1}{t_{1-2}} \right)$$

Installation and Connection

22 General Information on Installation

WARNING***Check danger through explosive gases***

Prior to beginning mounting, installation and maintenance make sure to observe any regulations on safety at work as well as to check the potential risk due to explosive gases. Use a gas warner to check.

When working in the channel system make sure to avoid electrostatic charge:

- *Avoid unnecessary movements to minimise the risk of static energy accumulating.*
- *Discharge any possible static electricity from your body before you begin to install sensors.*

Disregarding may lead to personal injury or damage your equipment.

22.1 Installation place

For safe installation at the chosen place the measures below must be taken:

- ➡ Protect the transmitter from direct sunlight. Install a protective cover if necessary.
- ➡ Observe the permitted ambient temperature.
- ➡ Do not expose the transmitter to heavy vibration or mechanical shocks.

Selecting the installation place strictly avoid:

- Corrosive chemicals or gases
- Radioactive radiation
- Installation close to footpaths or travel ways

22.2 Before Installation

CAUTION***Suspend the instrument only by using appropriate safety belts***

The instrument shall be suspended into shafts or manholes only by using the carrying handle and appropriate belts, ropes or similar.

It is not allowed to suspend the device by the sensor cable since this may lead to cable break, leaky plug connection or the transmitter may be torn off.

22.2.1 PU stickers on enclosure frame

- ➡ Prior to first use of the NivuFlow Mobile 600 make sure that the PU stickers have been removed. If not, remove the stickers and clean the enclosure frame if necessary.
- ➡ See chapter "12 Reception inspection".

22.2.2 Gaskets

- ➡ Check the gaskets on the enclosure cover.
Before closing the cover make sure that the gasket is clean and undamaged, so:
 1. Remove debris and/or dirt.
 2. Replace defective gaskets.

3. Apply silicone grease if necessary.



Gaskets

The NIVUS GmbH cannot be held responsible for any instrument damage resulting from the use of defective or leaking gaskets.

22.2.3 Securing the Instrument

- ➡ Secure the transmitter from being washed away.
When installed in shafts or canals tending to overflow the transmitter shall be secured against being washed away unintentionally (use suspension bracket, plastic/stainless steel rope, chain or similar).

22.2.4 Connection Sockets

- ➡ To protect open, unused connection sockets on the reverse side of the instrument from dirt or shocks lock the sockets by using the attached caps prior to installation.

The protection degree of the (closed) instrument is IP68 even with open connection sockets. Damaged or lost caps can be purchased from NIVUS.

23 Electrical Installation/Power Supply

WARNING



Danger due to electric voltage

*Remove the rechargeable batteries from the instrument and if connected to mains power via the multifunction socket disconnect from mains.
Working on the electric connections may induce the risk of electric shocks. Observe electric specifications as specified on the nameplate.*

Disregarding may lead to personal injury.



Note

Observe the local installation directives.

- ➡ Make sure to fulfil the requirements mentioned below:
 1. Observe that the installation shall be carried out only by qualified expert personnel.
 2. For electric installation follow the legal requirements of the according country (in Germany e.g. VDE 0100).
 3. Observe further (local) statutory standards, regulations and technical rulings.
 4. Before feeding the rated voltage the installation of transmitter and sensors must be completed. Verify whether the installation is correct.



A description on how to connect the sensors can be found starting page 37.

CAUTION



Do not loosen any screws

Do not loosen any screws on the transmitter except the undetachable hexagon socket screws of the battery compartment cover!

Keep the battery compartment locked during operation.

23.1 Rechargeable Battery Pack

NivuFlow Mobile usually operates with a rechargeable battery pack by default. This ready-to-use battery pack allows for long measuring periods.

- ➡ Ready-to-use battery packs are obtainable on order at NIVUS (see chap. "55 Accessories").

The battery pack is stored in the according battery compartment. An additional battery pack can be plugged right next to it. Since both sockets are almost equivalent the battery socket can be selected freely if only one battery pack is used.

- While **Charging** only the battery plugged into the right socket is charged however, and the battery will be charged only up to approx. 75 %.
- When **Discharging** the battery with the higher capacity (independent of the socket) is used until the capacity of both batteries has reached the same level. After that both batteries are discharged equally.

Moreover, the battery type used or the number of inserted batteries should be specified in the >Battery (12V)< menu to correctly indicate the remaining battery power in the >System</>Information< menu.

The battery compartment is locked with a cover and six non-detachable hexagon socket screws.



Installation of spare parts/parts subject to wear and tear

The use of spare parts/parts subject to wear and tear (such as rechargeable batteries) not approved by NIVUS will invalidate the guarantee.

23.1.1 Removing/Inserting the Rechargeable Battery Pack

WARNING



Risk of explosion removing/inserting the battery pack in Ex areas

Always remove/insert the rechargeable battery pack outside of Ex areas. Never replace the battery within an Ex area.

With the rechargeable battery pack removed make sure to not short-circuit the poles with external objects. This may generate very high short circuit currents resulting in the development of excessive heat or even fire which might destroy the rechargeable battery pack.

Observe the specifications on the rechargeable battery pack.

The rechargeable battery can be replaced even in damp weather conditions or during rain. The battery compartment is completely separated from the transmitter.

↻ Procedure:

1. Loosen the six non-detachable hexagon socket screws of the cover.
2. Remove the cover.
3. Remove the plugged battery on the grip belt.
4. After reinserting the rechargeable battery refit the cover and tighten the non-detachable hexagon socket screws of the cover finger-tight.

23.1.2 Charging the rechargeable battery pack

The rechargeable battery is normally shipped in discharged condition. Fully charge the battery prior to the initial instrument start.

NIVUS recommend charging the battery outside of the instrument by using the power adapter/battery charger to ensure 100 % of charging capacity. If built in, the battery will be charged only up to approx. 75 %.

WARNING



Risk of explosion removing/inserting and charging the battery pack in Ex areas

The rechargeable battery pack shall be removed/inserted and charged only out of Ex areas. Never do so within Ex areas since otherwise explosion protection cannot be guaranteed.



Power adapter/battery charger

To charge the rechargeable battery pack use the power adapter/battery charger (Fig. 23-1 no. 1; NFM0 ZLAD) (available from NIVUS GmbH at extra costs) only. Observe the specifications attached on the power adapter/battery charger.

Using inappropriate battery chargers may destroy the battery (e.g. due to leaking of battery cells, explosion or similar).



- 1 Power adapter/battery charger with connection cable for the multifunction socket on NFM or the charging tray
- 2 LED indicating the charging status

Fig. 23-1 Power adapter/battery charger

Disconnect the power adapter/battery charger (Fig. 23-1 no. 1) from mains power before you connect/disconnect it to/from a rechargeable battery.

The built-in LED (Fig. 23-1 no. 2) indicates the charging status.

Colour/LED Status	Description
Yellow	Charging process
Green	Trickle charging
LED not lit	Reversed polarity, short circuit or no mains power

Charging the inserted battery pack

See chapter "23.1.4 Operation/Charging with direct connection to mains power".

Charging the removed battery pack

➡ Procedure:

1. Place the charging tray in a safe and dry place on a stable and horizontal surface. Make sure the charging tray itself is dry too.

2. Take suitable measures to ensure that unauthorised persons may not access the devices during the charging process.
3. Plug the battery pack (Fig. 23-2 no. 1) into the charging tray (Fig. 23-2 no. 2) with the upside down.
4. Plug the power adapter/battery charger (with connection cable for multifunction socket) into the charging socket (Fig. 23-2 no. 3) and connect to mains power supply. The batteries are charged via the charging contacts (Fig. 23-2 no. 4). Observe the LED colour/status on the power adapter/battery charger.
5. To avoid short circuits on the charging contacts/poles after the charging process is finished, first disconnect the power adapter/battery charger from mains power and then remove the rechargeable battery pack.

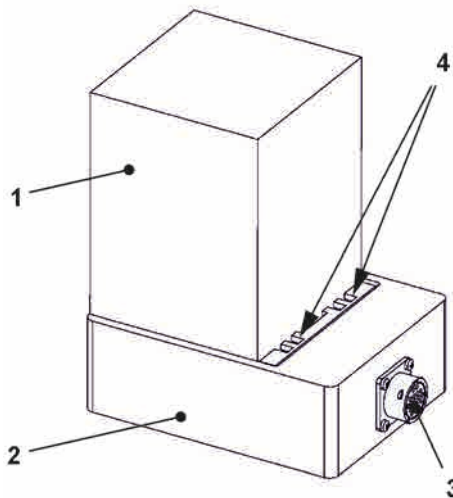

- 1 Rechargeable battery pack (plugged upside down)
- 2 Charging tray
- 3 Charging socket for connection of power adapter/charger
- 4 Charging contacts

Fig. 23-2 Rechargeable battery pack in charging tray

The maximum battery capacity will decrease over time. This impairs the battery life which, however, cannot be considered by the integrated battery life calculation.

If exposed to very low or very high ambient temperatures and long periods of use the capacity of the battery pack will decrease.



Battery life

Rechargeable batteries are wear parts and must be replaced once the charge capacity decreases considerably.

The battery life depends on the frequency of use.

Use for measurements

The battery should be charged every time before the NivuFlow Mobile is used.

Remove unused battery packs from the battery compartment after the last measurement and store them in a dry and frost-free place.



Installation of parts subject to wear and tear

The use of replacement parts/parts subject to wear and tear (e.g. rechargeable batteries) which are not approved by NIVUS invalidates the guarantee.

Battery disposal

Always observe environmentally compatible disposal of rechargeable batteries.

Worn batteries can be either returned to the manufacturer or can be taken to respective collecting points.

23.1.3 Operation/Charging via an Alternative Power Supply

WARNING



Risk of explosion removing/inserting the battery pack in Ex areas

Always remove/insert the rechargeable battery pack outside of Ex areas. Never replace the battery within an Ex area.

By using the multifunction socket the NivuFlow Mobile can be also operated with alternative power sources such as external rechargeable batteries, solar panels or external mains power adapter.

WARNING



Danger of explosion when operated with direct external power supply in Ex area.

*The unit shall be operated **only out of** des Ex areas when using a direct **external** power supply, **never inside of** Ex areas.*

During operation the battery pack is charged in the right-hand slot additionally. NIVUS, however, recommend the use of the battery charger since the battery will be charged to approx. 75 % of the total capacity when inserted (see chapter “23.1.2 Charging the rechargeable battery pack”).

NIVUS provides a particular 2-wire connection cable (*NFM0 ZVER PS*) with open cable ends on one side and a plug for the multifunction socket on the other side.

The NivuFlow Mobile power input accepts 12...14.5 V and is protected against overvoltage, overcurrent and reverse polarity.



Charge/Discharge battery sockets

*While **charging** only the battery plugged into the right socket is charged however.*

*When **discharging** the battery with the higher capacity (independent of the socket) is used until the capacity of both batteries has reached the same level. After that both batteries are discharged equally.*

23.1.4 Operation/Charging with direct connection to mains power

Thanks to the combined power adapter/battery charger (see Fig. 23-1) NivuFlow Mobile can be also operated directly with 100...240 V AC mains power.

WARNING



Danger of explosion during operation with direct mains power connection in Ex area

Do not operate the instrument within Ex areas using direct mains power connection but only out of Ex areas.

During operation the battery pack is charged in the right-hand slot additionally. NIVUS, however, recommend the use of the battery charger since the battery will be charged only to approx. 75 % of the total capacity (see chapter "23.1.2 Charging the rechargeable battery pack").

WARNING



Risk of explosion removing/inserting the battery pack in Ex areas

Always remove/insert the rechargeable battery pack outside of Ex areas. Never replace the battery within an Ex area.

Plug the battery to charge into the right battery socket and connect the power adapter/battery charger (Fig. 23-1) to the multifunction socket of the NivuFlow Mobile. Leave the battery in the instrument to charge it during mains power operation. In case of power failure the battery is used as buffer.



Charge/Discharge battery sockets

While charging only the battery plugged into the right socket is charged however.

When discharging the battery with the higher capacity (independent of the socket) is used until the capacity of both batteries has reached the same level. After that both batteries are discharged equally.

24 Sensor Installation in General

This chapter describes the sensor types and where they are usually installed. You can find detailed installation instructions for the individual sensor types in the installation instruction for transit time sensors.



Note

Always ensure compliance with the safety regulations during installation works.

The transit time difference method always uses 2 sensors per measurement path. These sensors shall be aligned to exactly face each other. Both sensors of a measurement path serve both as transmitter and receiver of ultrasonic signals. The sensor pairs are matched to each other per default. As a principle, the path sensors have the same cable length. Moreover the sensors within a path can be identified by the serial number.

24.1 Sensor Installation Basics

The sensor installation at the measurement place extremely depends on the conditions on site. Therefore always make sure that there are proper hydraulic conditions and an

appropriate calming section available on site. Sensor type and sensor fastening need to be determined depending on the measurement place.



Detailed information on how to select a calming section and the installation of sensors can be found in the according installation instruction.

The measurement place parameters need to be set prior to installation. Appropriate preparation measures and the measurement place dimensions can be taken from the respective plant documents.



Information on how to set measurement place parameters can be found in chapter "Parameter Setting" starting at page 62.

24.2 Installation of Clamp-On Sensors

Clamp-on sensors allow for contactless measurement in closed and full pipelines. Here the sensors are clamped from the outside onto pipes. The measurement itself **will not** influence the liquid and **will not** change the flow profile of the medium.

The following parameters must be specified before installing the clamp-on sensors:

- Pipe material
- Pipe outside diameter
- Pipe wall thickness
- Material of pipe lining
- Medium to measure (type of liquid)

Based on these specifications the transmitter calculates the accurate position data for the sensor installation. The mounting data can be viewed on the display and operation module (smartphone, tablet, notebook etc.).

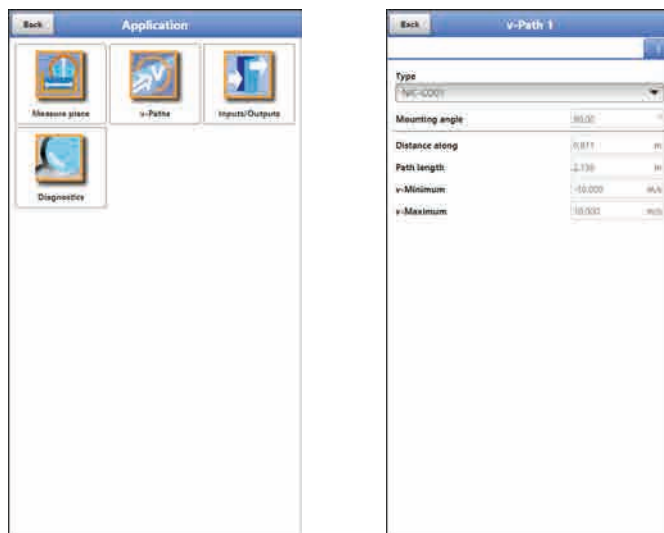

Fig. 24-1 Output of mounting data

The path arrangements below are usual for clamp-on flow metering:

- "Diametrical V" mode
- "Diametrical VV" mode
- "Diametrical VV" mode

The mounting distance between both sensors is the “clear distance”.

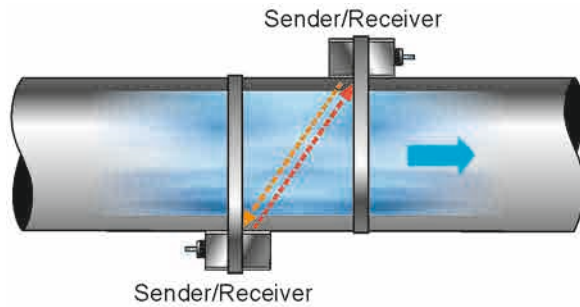

Fig. 24-2 Example “Diametrical \\' mode

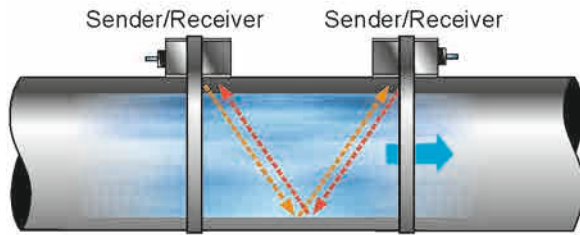

Fig. 24-3 Example “Diametrical V” mode

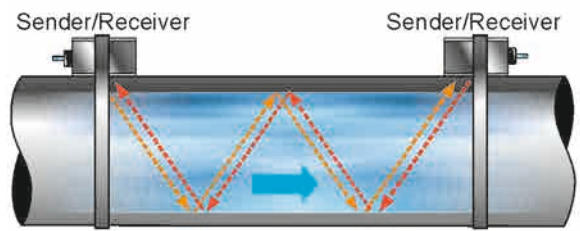

Fig. 24-4 Example “Diametrical VV” mode

24.3 Installation of wet Sensors



Engage pipeline experts

Wet sensors shall be installed only by a pipeline company or a plumber. The tightness of pipes must be guaranteed at any time.

The measurement is not influenced by pipe material or pipe wall thickness if wet sensors are used.

The pipe sensors are designed exclusively for full pipelines. These sensors are installed in pipelines from the outside by using a welding nozzle (90°) and a fastening element. The measurement paths are always directed through the pipe centre (diametrical).

The sensors or the nozzles required to insert the sensors can be pre-installed following the specifications. To do so, the number of paths as well as the path arrangement need to be determined first.

The measurement place parameters (selection of measurement method and number of paths) can be set in the >Measure Place< menu. The >v-Paths< menu is used to choose the sensor position for each path separately. To switch to the next path choose the according tab (1 or 2) on the top right.

The following parameters need to be specified:

- Pipe material
- Pipe outside diameter, internal pipe diameter or pipe circumference
- Pipe wall thickness

- Medium to measure

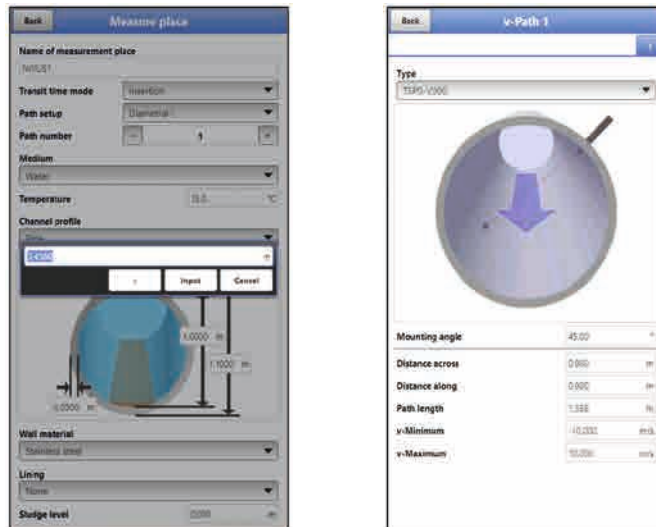

Fig. 24-5 Entering pipe dimensions and mounting angle

Based on these values the transmitter calculates the sensor positions as well as the path lengths needed for future measurements.

When positioning sensors or nozzles make sure to observe a parallel distance of 1x diameter (guideline) between the sensor centres per pipe crossing. If NIVUS pipe sensors are used the installation angle shall be 45°.

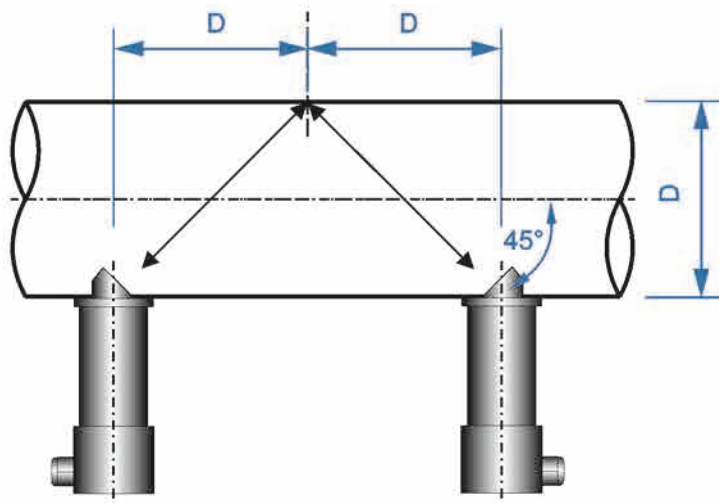

Fig. 24-6 Sensor distance - diameter (principle)

25 Sensor Connection

25.1 Cable for Sensor Connection

The sensors are equipped with a permanently attached cable.

The sensors of a **measurement path** basically have the same cable length. It is not allowed to extend or shorten the sensor cables.

25.2 Sensor Connection

A list of connectable flow velocity sensors can be found in chapter "16.2 Connectable Sensors".

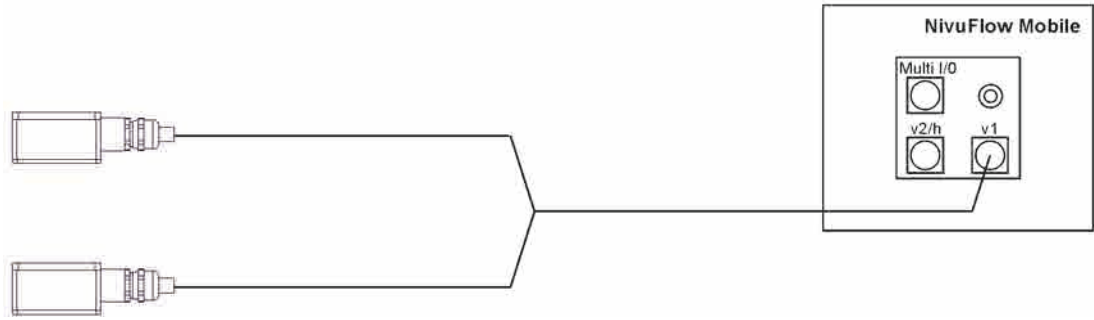

Fig. 25-1 Connection of flow velocity sensors, 1 pair/path

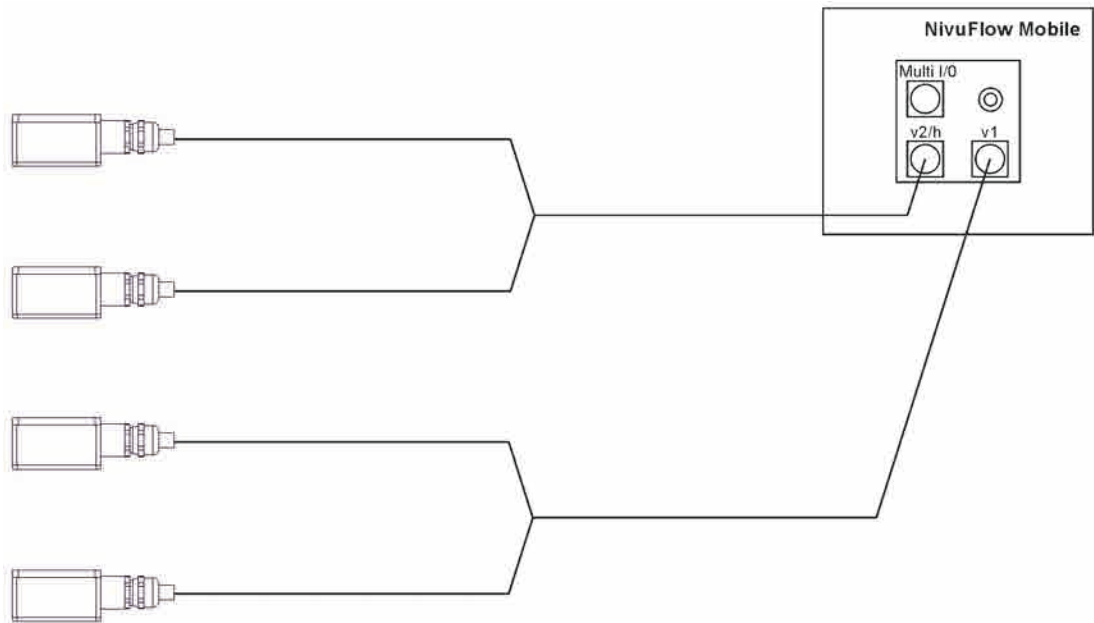

Fig. 25-2 Connection of flow velocity sensors, 2 pairs/paths

25.3 Overvoltage Protection Measures

To protect NivuFlow Mobile effectively if operated from external power supply it is necessary to protect the unit by using overvoltage protection equipment.

WARNING



Danger of explosion when operated with direct connection in Ex area

*Operate the unit **only out of Ex areas** using direct mains connection (e.g. mains plug adapter) or direct external power supply (e.g. solar power).*

Never do so within Ex areas.

If used with **mains plug adapter**, NIVUS recommend the types EnerPro 220Tr / 20kA or EnerPro 220Tr / 5kA (Fig. 25-3) in the mains side.

For **direct external power supply** using 12 V DC (e.g. solar power) the type DataPro 2x1 12V/12V-11µH-Tr(N) for non-Ex (Fig. 25-4) is recommended.



See chapter "55 Accessories".

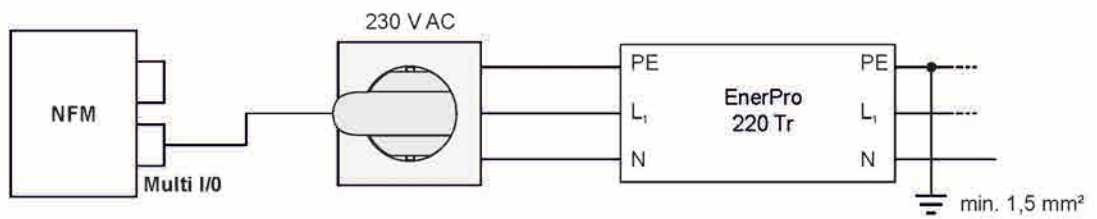

Fig. 25-3 General overvoltage protection for AC power supply

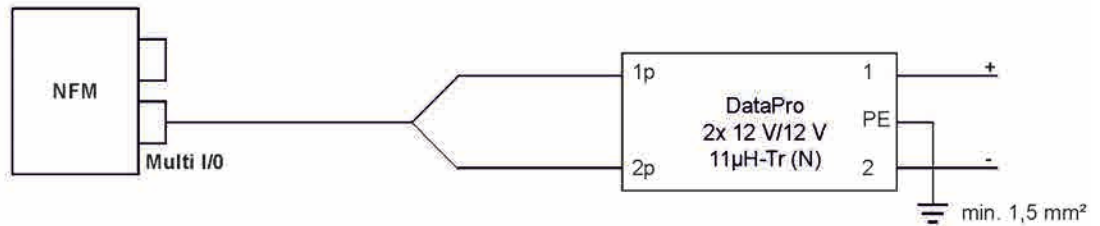

Fig. 25-4 General overvoltage protection for DC power supply

26 Single external Connection for Inputs/Outputs

If there is **one** additional sensor or actuator to be connected by using the inputs/outputs besides the sensors connected for flow velocity or level measurement, this can be done directly via the connection cables for the multifunction socket. Depending on the intended purpose there are different cable types available. All cables feature open cable ends on one side and a plug for the multifunction socket on the other side.

- ➡ For article numbers see chapter “55 Accessories”.
- ➡ For more than one external connection see chapter “27 Connecting the Connector Box for Inputs/Outputs”.

27 Connecting the Connector Box for Inputs/Outputs

A Connector Box (Fig. 26-1 no. 6) must be used if you wish to additionally connect **more than one** sensor or actuator using the inputs/outputs besides the flow velocity / level sensors on the NivuFlow Mobile 600 (Fig. 26-1 no. 1).

⇒ For only one single external connection refer to chapter “26 Single external Connection for Inputs/Outputs”.



Important Note

The Connector Box can either be fastened directly on the NivuFlow Mobile by using the hoop guards (Fig. 26-1 no. 2) or can be put/fastened to any other place.

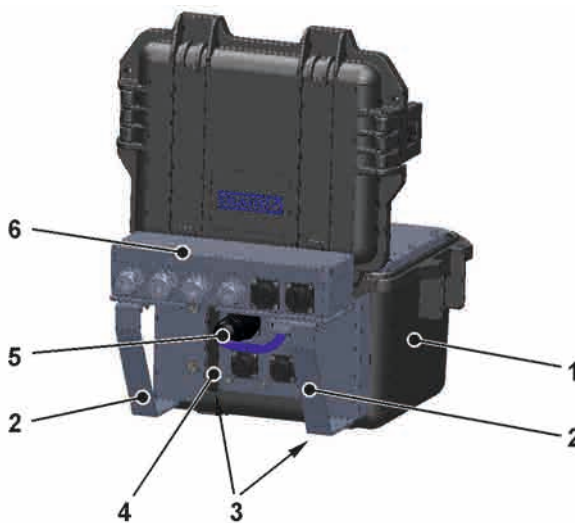

Fig. 27-1 NFM with Connector Box

➡ How to fasten the Connector Box on the NivuFlow Mobile:

1. Remove the rubber buffers (not depicted) from the reverse side of the NivuFlow Mobile (Fig. 26-1 no. 1). Both fastening plates (now loose, Fig. 26-1 no. 3) with-in the screw channels (Fig. 26-1 no. 4) and the rubber buffers are already required for the next step.
2. Fasten the hoop guards (Fig. 26-1 no. 2) and the fastening plates (Fig. 26-1 no. 3) on the NivuFlow Mobile by using the rubber buffers.
3. Fasten the Connector Box (Fig. 26-1 no. 6) on the hoop guards by using the accompanying screws.
4. Connect the sensors to the Connector Box. See terminal wiring diagram (Fig. 26-1).
5. Plug (Fig. 26-1 no. 5) the connection cable from the Connector Box into the multifunction socket on the NivuFlow Mobile.

⇒ For article numbers see chapter “55 Accessories”.

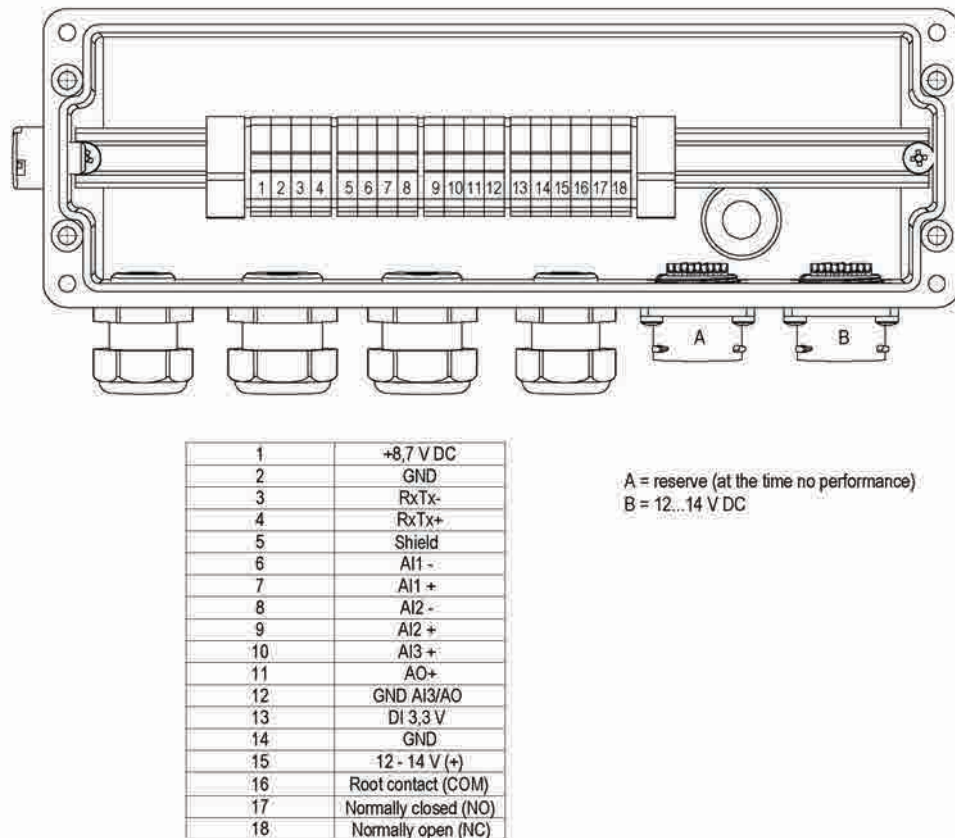

Fig. 27-2 Connector Box terminal wiring

Connection B on the Connectorbox is for external supply of the NFM transmitter (12...14 V DC) with the Connectorbox plugged via the power adapter / battery charger (see chapter "23.1.2 Charging the rechargeable battery pack") or the 2-wire connection cable (see chapter "23.1.3 Operation/Charging via an Alternative Power Supply").

28 (T-Shape) Antenna for GPRS Data Remote Transmission

The accompanying T-shape antenna is required for data remote transmission via GPRS.



Connect only antennas approved to this transmitter

The aerial socket is designed intrinsically safe. Do only connect the accompanying antenna or the types NFM0 ANT_x with longer connecting cables to the NivuFlow Mobile.

➡ Installation and connection procedure:

1. Plug antenna cable into the socket on the unit (Fig. 28-1) and tighten the screw joint manually.

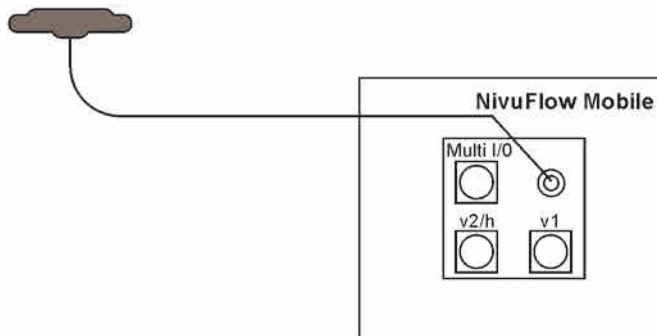

Fig. 28-1 Connection GPRS Antenna

2. Install the antenna at the highest possible position of the manhole or on the dust pan.
Note:
The T-Shape mobile communications antenna shall be installed in such a way that no persons are permanently (more than 6 minutes) present in a distance of less than 25 cm from the antenna.
As soon as the instrument operates correctly even shorter distances do normally not mean a danger to public health since the unit transmits only briefly on the mobile communications interface. As a precautionary measure this distance shall be complied with anyway.
3. If the unit is installed in a manhole close the manhole cover to verify that the data transmission works correctly even with the cover closed.
4. Set up a test connection using the communication parameter menu (see chapter "41 Parameter Menu Communication", >Modem state< / >Test connection<) to verify data transmission. If the connection is poor change the antenna position until the data transmission is sufficient.

Putting into Operation

29 Notes to Users

Before connecting and operating the NivuFlow Mobile follow the instructions below.

This instruction manual contains any information required for the setting of parameters and the operation of the instrument. The manual is intended for technically qualified personnel. Appropriate knowledge in the areas of measurement system, automation technology, control engineering, information technology and wastewater hydraulics are prerequisites to put the NivuFlow Mobile into operation.

Carefully read this instruction manual in order to guarantee proper function of the NivuFlow Mobile. Connect the NivuFlow Mobile according to chapter "25.2 Sensor Connection".

In case of doubt regarding installation, connection or the setting of parameters contact our hotline:

- +49 (0) 7262 9191 955

General Principles

Do not put the system into operation before the installation has been completely finished and checked.

Follow the hints in the instruction manual to eliminate the risk of faulty or incorrect parameter settings. Get familiar with the transmitter operation before you begin to set the parameters.

After transmitter and sensors are connected (according to chapters "24 Sensor Installation in General" and "25 Sensor Connection") the measurement place parameters can be set.

In most cases it is sufficient to set:

- shapes and dimensions of the measurement place
- sensors used and the according positions
- display units
- storage mode

The NivuFlow Mobile user surface is easy to understand. The basic settings can be easily adjusted by users themselves.

A startup wizard is available to facilitate the initial startup. The wizard will guide the user through the most important parameter settings in easy steps (see chapter "42 Parameter Menu Quick Start").

30 Indication System of Status LED on NivuFlow Mobile

The status LED (Fig. 30-1) on the front side of the NivuFlow Mobile follows a predetermined system which indicates the current status of the instrument.

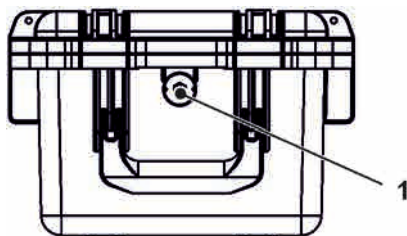

Fig. 30-1 LED on the NFM front

Once the NFM is in full working conditions without limitation the LED is lit **green**: 1x long, pause, 5x short.

The same intervals apply as soon as there is one error message pending at least. The LED then, however, is lit **red**.

Blue flashing in the pause between the first long flash and the five successive flashes indicates the number of users logged in: 1x for each user (max. number of possible users logged in is four).

➡ See also chap. “35 General Programming”.

The LED is lit in **white** while the system is booting e.g. after plugging in the rechargeable battery or after a firmware update.

➡ See also chap. “40.5.6 Update NivuFlow”.

31 Setting Up Connection

31.1 General

The NivuFlow Mobile is operated completely by using a standard smartphone/tablet or via notebook/PC. Use the preferred display and operation module according to the respective manufacturer specifications.

The following sections describe the connection setup procedures for Android, iOS and Windows.

31.2 Android Operating System

➡ Preparing the NivuFlow Mobile:

1. Ensure power supply: a minimum of one completely charged rechargeable battery pack either plugged into the instrument or alternatively connected via the multifunction socket (see chapter “23.1.3 Operation/Charging via an Alternative Power Supply”).
The following step “Wake-Up” can be skipped as soon as the battery pack is inserted now or when voltage is fed and the connection is set up within the following five minutes.
2. “Waking up” NivuFlow Mobile: hold the accompanying magnet (solenoid, Fig. 31-1 no. 2) to the reed contact (Fig. 31-1 no. 1; on front side of NFM) until the LED is lit.

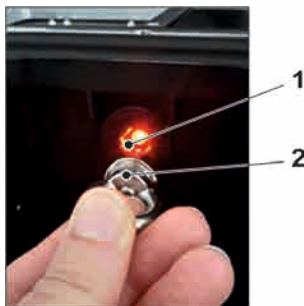

Fig. 31-1 Waking up the NivuFlow Mobile

➡ Steps on the display and operation module (smartphone, tablet, notebook, PC etc.):

1. Start the display and operation module.
2. Use the “Settings” symbol (Fig. 31-2 no. 1) to open the according menu.

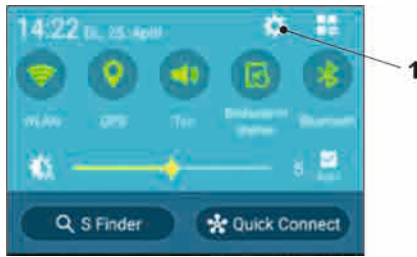

Fig. 31-2 Settings symbol

3. Select WLAN (Fig. 31-3 no. 1).

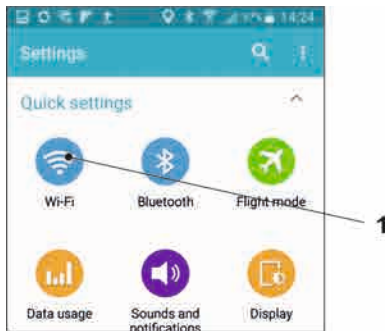

Fig. 31-3 WLAN symbol

4. From the list of available WLANs select the NFM (Fig. 31-4 no. 1) with the according SSID (default state = serial no.).

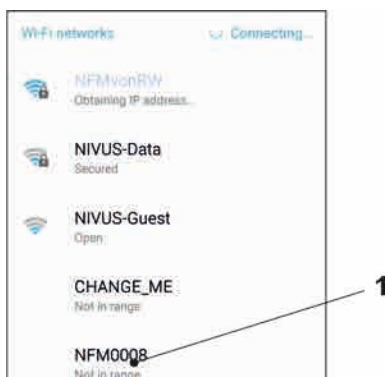

Fig. 31-4 WLAN List

5. Enter the password for server access (default state = PUK) (Fig. 31-5 no. 1) and connect (Fig. 31-5 no. 2).

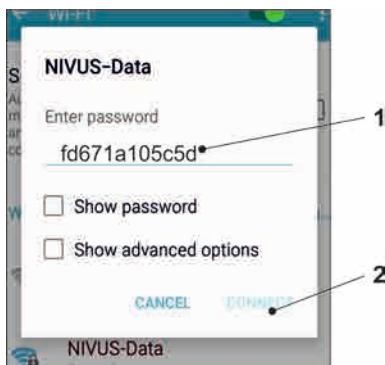

Fig. 31-5 Enter password (example here fd671a105c5d) and connect

6. Start the Internet browser.

7. Type "192.168.1.1" into the IP address field and open. The NivuFlow Mobile display (Fig. 31-6) is indicated as soon as the connection has been established successfully.

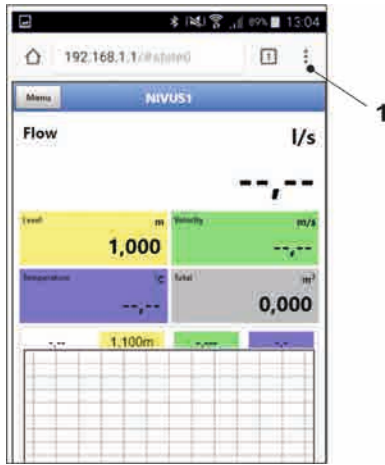

Fig. 31-6 NFM display in browser

8. To set a link on your "Home screen" (for direct access) use the "Tabs and Settings" symbol (Fig. 31-6 no. 1) and select "Add to Home screen" (Fig. 31-7 no. 1).

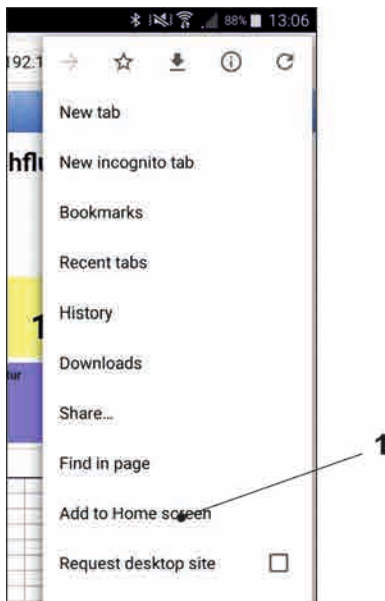

Fig. 31-7 Add to Home screen

9. Use "Add" to confirm (Fig. 31-8 no. 1).

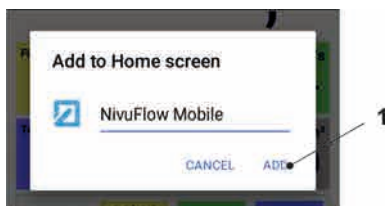

Fig. 31-8 Confirm adding

The link (Fig. 31-9 no. 1) is indicated on the tart screen and can be used for instant access without the need to specify the IP address.

This link can be used for each further NivuFlow Mobile transmitter after it has been selected from the WLAN list.



Fig. 31-9 Link in the start screen

31.3 iOS Operating System

➤ Preparing the NivuFlow Mobile:

1. Ensure power supply: a minimum of one completely charged rechargeable battery pack either plugged into the instrument or alternatively connected via the multifunction socket (see chapter “23.1.3 Operation/Charging via an Alternative Power Supply”).
The following step “Wake-Up” can be skipped as soon as the battery pack is inserted now or when voltage is fed and the connection is set up within the following five minutes.
2. “Waking up” NivuFlow Mobile: hold the accompanying magnet (solenoid, Fig. 31-10 no. 2) to the reed contact (Fig. 31-10 no. 1; on front side of NFM) until the LED is lit.

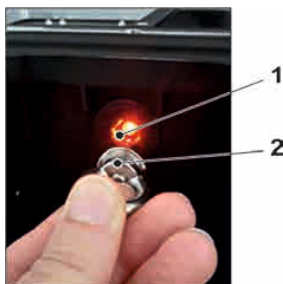

Fig. 31-10 Waking up the NivuFlow Mobile

➤ Steps on the display and operation module (smartphone, tablet, notebook, PC etc.):

1. Start the display and operation module.
2. Use the “Settings” symbol (Fig. 31-11 no. 1) to open the according menu.



Fig. 31-11 Settings symbol

3. Select WLAN (Fig. 31-12 no. 1).



Fig. 31-12 WLAN symbol

4. From the list of available WLANs select the NFM (Fig. 31-13 no. 1) with the according SSID (default state = serial no.).



Fig. 31-13 WLAN List

5. Enter the password for server access (default state = PUK) (Fig. 31-14 no. 2) and join (Fig. 31-14 no. 1).

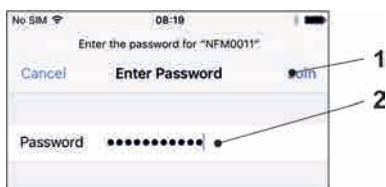

Fig. 31-14 Enter password and join

6. Start the Internet browser.
7. Type "192.168.1.1" into the IP address field and open. The NivuFlow Mobile display (Fig. 31-15) is indicated as soon as the connection has been established successfully.

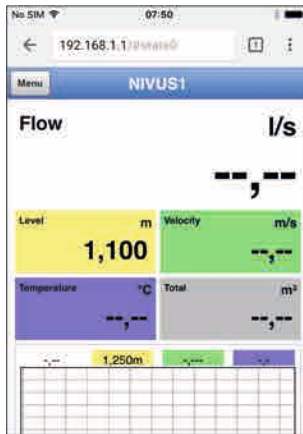

Fig. 31-15 NFM display in browser

8. Use the symbol “Provide” (Fig. 31-16 no. 1) to set up a link on your home screen (for direct access).

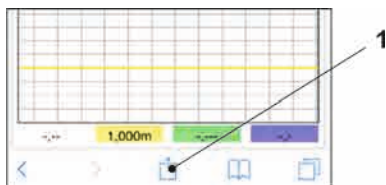

Fig. 31-16 Set up link

9. Select “To Home Screen” (Fig. 31-17 no. 1).



Fig. 31-17 To Home Screen

10. Confirm with “Return” (Fig. 31-18 no. 1).

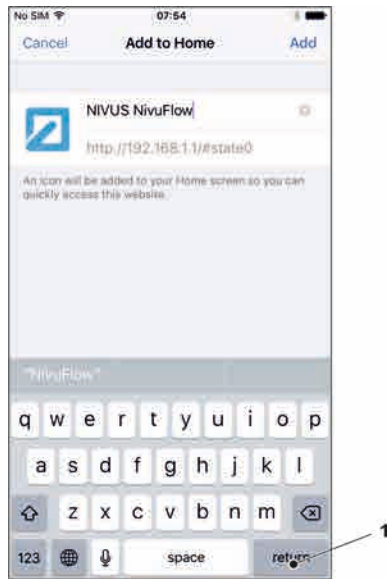

Fig. 31-18 Confirm adding

The link (Fig. 31-19 no. 1) is indicated on the tart screen and can be used for instant access without the need to specify the IP address.

This link can be used for each further NivuFlow Mobile transmitter after it has been selected from the WLAN list.



Fig. 31-19 Link in the start screen

31.4 Windows Operating System

➡ Preparing the NivuFlow Mobile:

1. Ensure power supply: a minimum of one completely charged rechargeable battery pack either plugged into the instrument or alternatively connected via the multifunction socket (see chapter "23.1.3 Operation/Charging via an Alternative Power Supply").
The following step "Wake-Up" can be skipped as soon as the battery pack is inserted now or when voltage is fed and the connection is set up within the following five minutes.
2. "Waking up" NivuFlow Mobile: hold the accompanying magnet (solenoid, Fig. 31-20 no. 2) to the reed contact (Fig. 31-20 no. 1; front side of NFM) until the LED is lit.

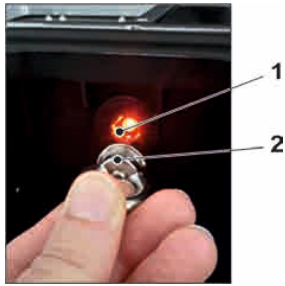

Fig. 31-20 Waking up the NivuFlow Mobile

➡ Steps on the display and operation module (smartphone, tablet, notebook, PC etc.):

1. Start the display and operation module.
2. Go to the list of available (WLAN) networks (Fig. 31-21 no. 2).
3. From the list select the NFM (Fig. 31-21 no. 1) with the according SSID (default stat = serial no.).



Fig. 31-21 List of (WLAN) networks (example)

4. Enter the security key (password) (default state = PUK; example here fd671a105c5d) (Fig. 31-22 no. 1) and connect.

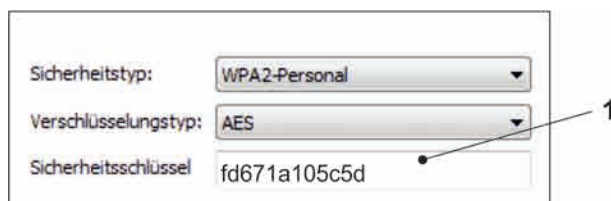

Fig. 31-22 Enter security key and connect

5. Start the Internet browser.

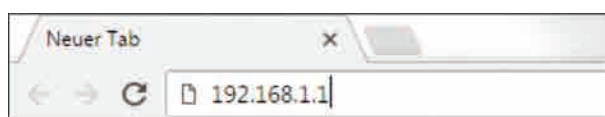

Fig. 31-23 Address field

6. Type "192.168.1.1" into the IP address field (Fig. 31-23) and open. The NivuFlow Mobile display (Fig. 31-24) is indicated as soon as the connection has been established successfully.



Fig. 31-24 NFM display in browser

- To create a browser favourite (for direct access) click the “Favourites” star (Fig. 31-25 no. 1, example here Google Chrome) and confirm with “Finished” (Fig. 31-25 no. 2).



Fig. 31-25 Set up favourites

The bookmark is shown in the bookmarks list (Fig. 31-26 no. 1) and can be used for instant access without the need to specify the IP address.

This link can be used for each further NivuFlow Mobile transmitter after it has been selected from the WLAN list.

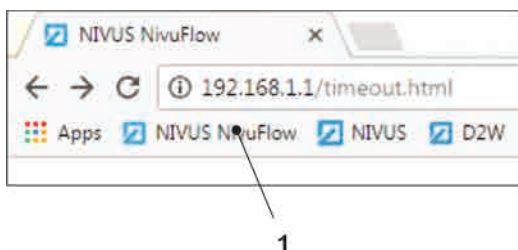
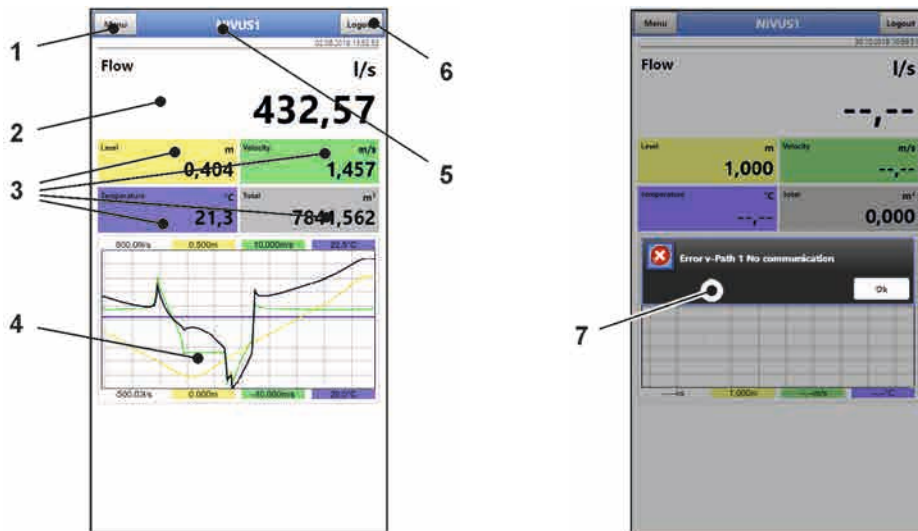

Fig. 31-26 Link in the bookmarks bar

32 Menu Operation/Overview

32.1 Display Overview

The NIVUS display at any time provides an overview on where you currently are within the menu structure and which entries you are about to modify.



- 1 Menu / Back (depending on display view)
- 2 Display area 1 (output field 1 for flow metering)
- 3 Display area 2 (output field 2...5 for level, average velocity, medium temperature and totaliser)
- 4 Display area 3 (trend graph on level, velocity, medium temperature and rate)
- 5 Name of measurement place
- 6 Logout (disconnection of display and operating module from transmitter; transmitter continues operation using the latest saved settings)
- 7 Possible error message, information or indication of active service mode (shown only once as separate window in the centre of the screen right after opening; close with "Ok")

Fig. 32-1 Display

32.2 Saving Parameters

After modifying parameters and navigating back using the menu field save the modified parameters to make the changes effective. Once saved the status message “Successful” is shown.



Fig. 32-2 “Rearrange Paths” and “Save Parameters”

➡ For saving procedures see chapter “35.1 Save Parameters”.

32.3 Menus

All menus are described in chapter "Parameter Setting" as logical programming sequence starting at page 62.

The main menu contains eight basic menus which can be viewed and selected either by choosing the "Menu" field (from the main screen) or "Back" (from within the submenus).

The menus are:

Application	Guides the commissioning personnel through the entire setting of parameters for the dimensions of measurement places, selection of sensors, analog/digital inputs and outputs and diagnostics
Data	<ul style="list-style-type: none"> - Graphic representation of historic data on flow rate, level and (average) flow velocity - Indication of 24-hour day totals as tables - Saving of data - Saving and loading of parameters
System	<ul style="list-style-type: none"> - Basic information (serial no., version, article no. etc.) on the transmitter (required by NIVUS GmbH in case of requests) - Language and date format settings under >Country Settings< - System time and time zone settings under >Time/Date< - Error messages under >Error Messages< - Service levels - Configuration of storage cycle - Parameter Reset - Feature unlock - Instrument shutdown (powerdown) - Information on batteries and the current capacity
Communication	Parameters for the configuration of NivuFlow Mobile communication interfaces
Display	Output fields settings (text, decimal places etc...)
Battery (12V)	To choose the batteries/rechargeable used
Quick Start	Guided, quick parameter settings for simple measurement places
Alert	Activation of alarms in case of sensor errors and setting of high or low limit values/thresholds used to trigger alarms via e-mail using the NIVUS Web Portal

Table 4 Menu overview

Start-Up Examples

33 Measurement with Clamp-On Sensors

33.1 General

Measurements with clamp-on sensors can be carried out very easy and with little effort. The sensors are installed on the outside of the pipe.

Prior to the installation of clamp-on sensors the measuring section shall be prepared and the measurement place parameters need to be set. For the measurement place basically the parameters below must be set:

- Number of paths and path arrangement
- Medium to measure
- Pipe circumference or inside pipe diameter or outside pipe diameter
- Wall thickness
- Wall material
- Inner lining material if available

The transmitter uses these settings to calculate the positions of the clamp-on sensors.

After the measurement place parameters have been set the sensor position data can be directly viewed on the display of the operation module.



Observe the instructions on how to prepare the measuring section in the "Installation Instruction for Transit Time Sensors".

33.2 Programming a 1-path diametrically opposed Measurement

In order to set the parameters of a diametrical 1-path measurement it is necessary to enter all measurement place data into the transmitter. Prior to programming we recommend you to become familiar with chapter "35 General Programming" starting at page 62. Chapter "38.1 Menu Measure Place" starting at page 73 describes how to set the measurement place parameters.

33.2.1 Simple Parameter Setting

Application Specifications:

- Stainless steel (steel)
- No inner lining
- No sediments in the pipe
- "Diametrical \ " path arrangement
- 1 path

Procedure:

1. Select "Menu" (top left).
2. Open >Application< menu.
3. Open >Measure Place< menu.
4. Specify measurement place name and confirm with "Enter".
5. Select transit time mode >Clamp-On<.

- Specify path arrangement (“Diametrical \”) and number of paths (1 path).

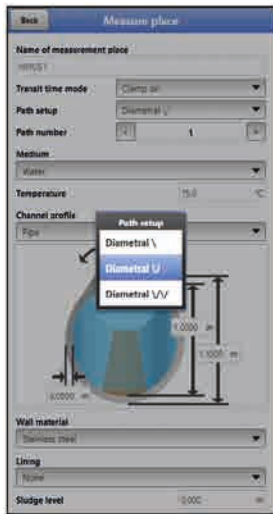

Fig. 33-1 Select path arrangement



Hints on the Medium

If you cannot find your medium to measure within the list select “User defined”. Another menu opens up which can be used to specify e.g. the speed of sound within the medium.

Tip:

Various speeds of sound can be found in the Internet.

- Use the selection menu to specify the medium to measure and to select/specify the current medium temperature.
- Set the channel profile to “Pipe”.
The graphics area indicates a pipe featuring four input fields.
- Enter the pipe data (example: DN1000). Two specifications are sufficient to enter the pipe dimensions such as inside diameter and wall thickness in this example.



Fig. 33-2 Specifying pipe dimensions

As soon as inner diameter and wall thickness are specified the transmitter automatically adds outside diameter and pipe circumference. The same applies after circumference and wall thickness have been specified. The transmitter will add the rest of the parameters.

10. Select the wall material from the menu (stainless steel).

More specifications are not required – the following parameters (lining, sludge level etc.) remain to default state.

Once a relevant parameter in menus >Measure Place< or >v-Paths< has been changed it is necessary to re-initialise the path arrangements in order to recalculate path lengths and sensor positions.

➡ Exit menu “Measure Place” menu **to adjust the Measurement Path Settings.**

1. Go to >Application< menu.
The following query appears on the display:

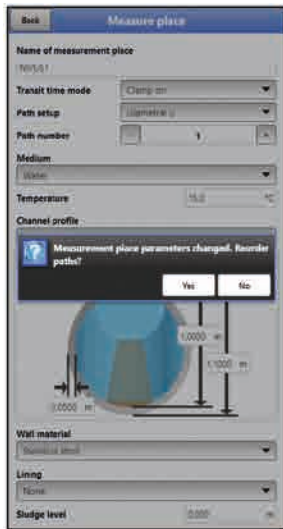

Fig. 33-3 Accept modified measurement place parameters

2. Confirm modified parameters and path rearrangement. The display shows “Initialised!” after confirmation with >Yes<.

➡ **Sensor Selection and Specification of Mounting Angle** procedures:

1. Select menu >v-Paths<.
2. Choose the sensor type used.
3. Enter the mounting angle (+45° or -45°) and confirm.



Fig. 33-4 Enter the mounting angle (Clamp-On)

The >Distance along< field on the display indicates the distance between both sensors. The indicated distance is always the clearance between both sensors.

All other parameters are read-only or remain to be set to default.

➡ Once entered, all required measurement place Parameters need to be saved:

1. Use “Back” to exit the menus until >Save Parameters?< is shown on the display.
2. Confirm >YES<. NivuFlow Mobile goes to the main screen. Use “Back” to return to the main menu. After pressing “Back” once again and saving the transmitter switches over to the main screen and uses the new parameters.

33.2.2 Extended Parameter Setting

More specifications:

- Pipe with inner lining
- Sedimentation within the pipe

For pipes with inner lining:

➡ Procedure:

1. Execute steps 1 (“Menu” field, page 58) up to and including 10 (“wall material”; page 60) as described in chapter “33.2.1 Simple Parameter Setting”.
2. Select the >Lining< material. The thickness of the lining is now included in the graphics area. The NivuFlow Mobile requires this extra value for calculations including the lining.
3. Indicate the lining thickness in the graphics area.
4. If moreover there should be sedimentation within the pipe enter the according value in >Sludge Level< and confirm. The transmitter then will subtract this sludge level from the wetted hydraulic total area while calculating the flow rate.
5. To save your entries go “Back” and confirm the path modification/arrangement with >Yes<.
6. Menu >v-Paths<: choose sensor and specify the mounting angle. Here you can read the >Distance along< and the >Path length< values required to install the clamp-on sensors.

34 Measurement with wet Sensors

The setting of parameters for a measurement place using wet sensors is essentially in line with the parameter setting procedures used for clamp-on sensors.

When selecting the >Transit Time Mode<, consider that the >Path Arrangement< option provides more variations and >Distance across< is indicated additionally when viewing the mounting values.

Parameter Setting

35 General Programming

As a principle, modified parameters do not become effective before they have been saved. The instrument verifies whether parameters have been changed when you exit menus by using "Back". Finally, you will be prompted to eventually save modified parameters.

- >Yes<: modified parameters are accepted and saved.
- >No<: parameter modifications are rejected and the instrument will exit the menus.
- >Abort<: you will exit the prompt. Parameters remain to be modified, however will not become effective and will not be saved.



Tip to repeatedly measure the same measurement places

If certain measurement places are to be measured not only once, but again and again it is recommended to save the according parameter settings and readings (if required) on USB stick. This eliminates the need to readjust parameters for the next measurement at the respective measurement place by simply reloading the required data from the stick to the transmitter.

For more details see chapter "39.3 Data Memory" starting at page 89.

35.1 Save Parameters

Once all necessary (measurement place) parameters are specified, the data must be saved in order to become effective.

➡ Procedure (2 stages):

1. Select "Back": the message >Measurement Place Parameters modified. Reorder Paths?< is shown. Confirm with >Yes< *1.
The "Initialised!" message indicates successful initialisation.

*1 Initialise modified parameters (in current menu) with >Yes<; >No< will abort initialisation process, the last modified values remain active and the initialisation process (in current menu) can be continued; to actually abort initialisation select >No< if prompted >Save Parameters?< in the next step.

2. Select "Back" twice: a window opens asking >Save Parameters?<. Confirm with >Yes< *2.
The message "Successful!" indicates that the parameters have been saved.

*2 >Yes< saves the new parameters; >No< will abort the saving process leaving the last modified parameters active again; >Abort< will abort the saving process, the last modified parameters remain active and the initialisation process can be continued.

35.2 Change WLAN Password

The WLAN password is set to an individually determined ID **per default**. This ID can be found on a label on the top of the instrument (inside of the enclosure).

The default password can be changed as described below. The new password must have between 8 and 32 characters.

➡ Procedure:

1. Open the main menu with "Menu".
2. Open >Communication<.
3. Open the >WLAN< menu.

4. Select >Password<.
5. Enter the new password and confirm.

Up to four users may have access to transmitter and parameters simultaneously via WLAN. Simultaneous access will not be indicated or logged.

Necessarily observe to agree parameter changes in order to avoid several users accessing the parameters at the same time. Always the latest saving process applies.



Store password in a safe place

Never give the password to unauthorised persons.

If you need to note down the password always keep it in a safe place.

35.3 Change Instrument SSID

The SSID is set to the serial number of the instrument **per default**. The serial number can be found on the nameplate on the side of the enclosure.

The default SSID can be changed as described below. A new SSID must have between 8 and 32 characters.

➡ Procedure:

1. Open main menu via "Menu".
2. Open >Communication< menu.
3. Open >WLAN< menu.
4. Select >SSID< field.
5. Enter new name and confirm.

35.4 Lost Password

Each NivuFlow Mobile is shipped with an individual PUK ("Personal Unblocking Key" or Super-PIN) which permits to create a new password and to reactivate the instrument.

The PUK is identical to the default WLAN password and can be found on a label attached on the transmitter top (inside of enclosure).

➡ Procedure:

1. Open cover.
2. Loosen hexagon socket screws of battery compartment cover and remove the cover.
3. Remove the rechargeable batteries.
4. Hold the magnet to the reed contact and plug a battery simultaneously. The magnet must be held to the reed contact for at least 15 seconds until the LED flashes red several times. The NivuFlow Mobile is "woken up".
5. The WLAN list indicates the NFM with the default SSID (identical to the serial no. of the according instrument as specified on the nameplate).
6. Enter the default PUK as password.
7. Enter new password and, if required, SSID according to chapters "35.2 Change WLAN Password" and "35.3 Change Instrument SSID".
8. To accept the new password/SSID reinitialise the instrument by removing and reinserting the rechargeable batteries.
9. Activate the NFM within the next five minutes. Otherwise the modified password will not be accepted, the instrument will continue to use the default ID and will only respond to the default password.

10. Insert second battery if required.
11. Refit the battery compartment cover using the hexagon socket screws and close the cover.

35.5 Automatic Data Transmission to USB Stick

In standard situations data stored in the NivuFlow Mobile are transmitted to the display and operation module via WLAN.

 See chapter “39.3 Data Memory”.

If, in exceptional cases, this should not be possible e.g. due to the lack of WLAN, display and operation module malfunction or empty batteries, it is possible to read out the data memory automatically by using a plugged USB stick.



Using the USB interface is allowed only outside of Ex areas.

 Procedure:

1. Open enclosure.
2. Plug USB stick.
3. “Wake up” the NivuFlow Mobile with the magnet (solenoid).
The transmitter automatically transmits the entire content of the measurement data memory to the plugged USB stick as soon as no WLAN connection is available within 5 minutes. The status LED on the transmitter flashes green during transmission.
4. Data transmission is finished once the status LED has stopped flashing. The USB stick can then be removed.

36 Parameter Setting using Quick Start

This menu allows easy setting of parameters for elementary measurement places with the aid of default settings for various parameters.

⇒ The >Quick Start< menu is described in greater detail in chapters “37.2.7 Menu - Quick Start” and “44 Parameter Menu Quick Start”.

➡ Procedure:

1. Open main menu.
2. Select >Quick Start< menu.
The query >Create new Measurement Place?< appears.

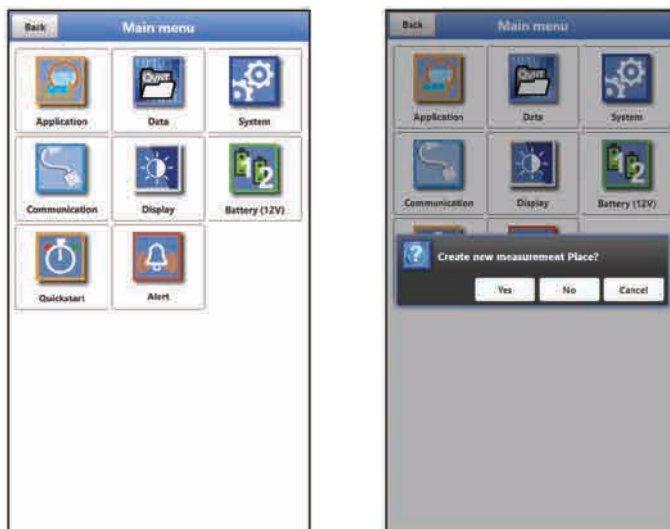

Fig. 36-1 Quick Start with query

3. Choosing >No< opens the >Region Settings< page of the >Quick Start< menu. Choosing >Yes< will ask >Are you sure? Old parameters and archive data will be lost!<. Selecting >Yes< here will erase the old parameters and archived data and indicates “Successful!” once the procedure is completed. >No< erases nothing and opens the >Region Settings< page.

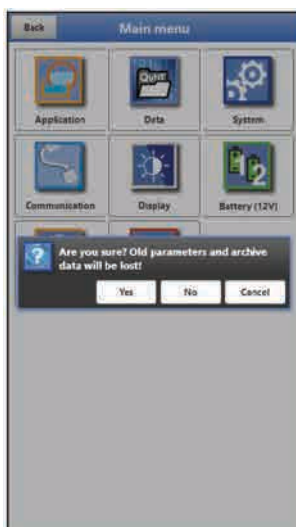

Fig. 36-2 Confirmation prompt “Erasing Parameters and Data”

4. On page >Region Settings< set the language, the date format, the required units and the storage mode (operating mode and storage cycle).



Fig. 36-3 >Country Settings< menu

5. Use the arrow keys to go to the next page >Measure Place<.
6. Set the measurement place parameters: specify name, transit time mode, path arrangement, number of paths, medium, temperature (of medium), channel profile including dimensions, wall material and lining if available.

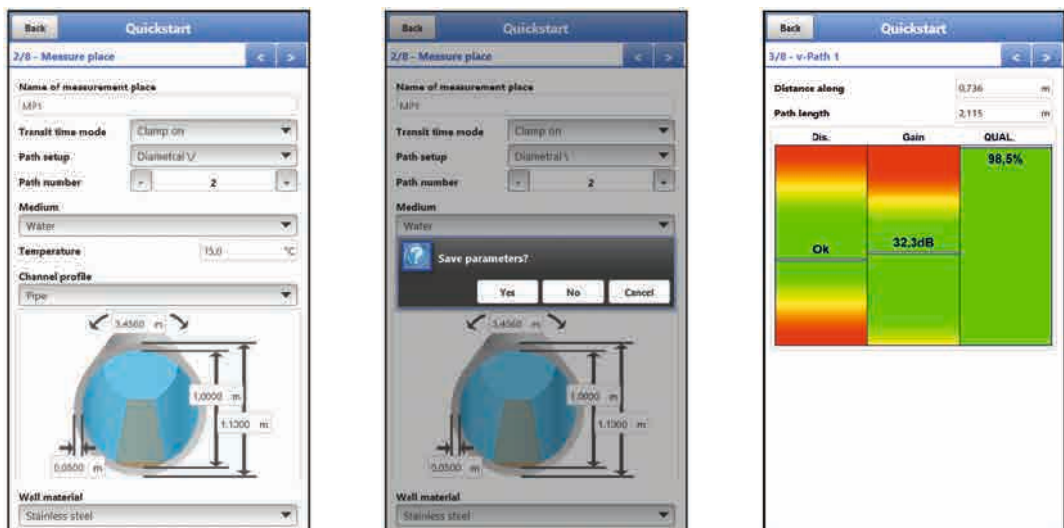

Fig. 36-4 >Measure place< />Region settings< />v-Path 1<

7. Use the arrow keys to go to the next page.
You will be prompted to save parameters.
>Yes< will save and open the next page >v-Path 1<.
>No< will not save anything and takes you to the next page >v-Path 1<.
Choosing >Abort< remains the current page >Measure Place< open enabling to continue the setting of parameters here.
Page >v-Path 1< (in case of two paths there is also page >v-Path 2<) is a read-only page. Here the mounting data of the flow velocity sensors as well as the signal strength can be viewed.
8. Use the following pages to set the parameters of analog and digital inputs depending on the application.
9. Finally the system will ask you to save the parameters or use "Back" to return to the main menu.

37 Parameter Functions

37.1 Main Menu

The NivuFlow Mobile 600 parameters can be set using a total of eight menus which are described in greater detail starting with chapter "37.2.8 Menu - Alert".

The main menu indicates eight icons containing the functions described in the following chapters.



Fig. 37-1 Overview Main Menu

37.2 Functions of the first Menu Level

37.2.1 Menu - Application

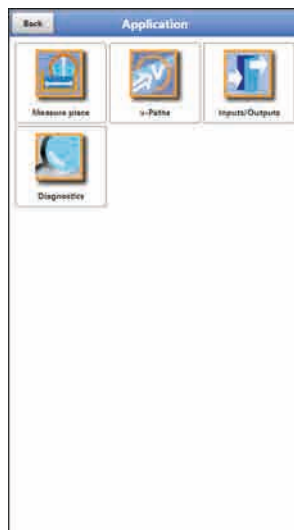

Fig. 37-2 Menu Application

This is one of the most relevant basic menus when it comes to setting parameters. The Application Menu contains four sub-menus where shapes and dimensions of measurement places can be set. It is used to define the flow velocity sensors as well as to set mounting position data.

Moreover the required analog and digital inputs and outputs can be defined here:

- Functions

- Measurement ranges
- Measurement spans
- Limit values

This menu includes diagnostic options for:

- Flow velocity sensors
- Inputs and Outputs
- Total system
- Signal analysis
- Simulation

Use this menu to enter or change:

- Constant, fixed sludge levels
- Low flow suppression
- Damping and signal evaluation and signal output
- Stability of signal evaluation and signal output

37.2.2 Menu - Data



Fig. 37-3 Menu Data

The data menu contains all internal stored measurement values.

Following functions are available:

- Graphic representation of measurement values
- List of the 100 latest 24h day totals
- Communication and transmitting option of internal data
- Transfer of adjusted parameters to and from USB stick
- Options to set and to erase the internal data memory

37.2.3 Menu - System



Fig. 37-4 Menu System

This menu contains information on the transmitter:

- Firmware version
- Article number
- Serial number
- Information on battery voltage and credits/licenses

The following settings can be adjusted additionally:

- Language
- Units
- Date and time correction
- Read active error messages
- Erase error memory
- Configure storage cycle
- Instrument shutdown (Powerdown)
- Parameter reset
- Unlock licensed functions
- Update firmware

37.2.4 Menu - Communication



Fig. 37-5 Menu Communication

This menu includes settings required for communication with other systems:

- WLAN
- GPRS

37.2.5 Menu - Display



Fig. 37-6 Menu Display

This menu defines the five display fields of the main screen.

37.2.6 Menu - Battery (12V)



Fig. 37-7 Menu Battery (12V)

This menu is used to choose type and number of the batteries used.



Correct Capacity Indication

The capacity indication in the >System< / >Information< menu works reliably only as long as completely charged batteries are used and the type and number of the batteries used are specified here.

37.2.7 Menu - Quick Start

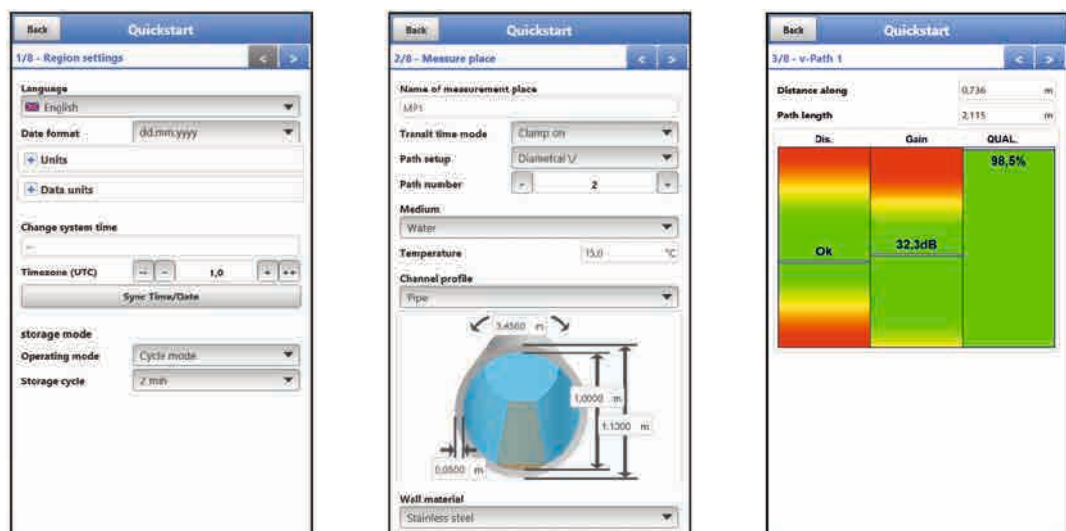

Fig. 37-8 Menu Quick Start

This menu allows easy setting of parameters for elementary measurement places with the aid of default settings for various parameters.

Depending on the number of connected v-sensors/paths and the use of the analog and digital inputs there are up to eight pages in the >Quick Start< menu:

- Page 1 >Region Settings<
- Page 2 >Measure place<
- Page 3 >v-Path 1<
- Page 4 >v-Path 2<

- Page 5 >Analog Input 1<
- Page 6 >Analog Input 2<
- Page 7 >Analog Input 3<
- Page 8 >Digital Input 1<

37.2.8 Menu - Alert

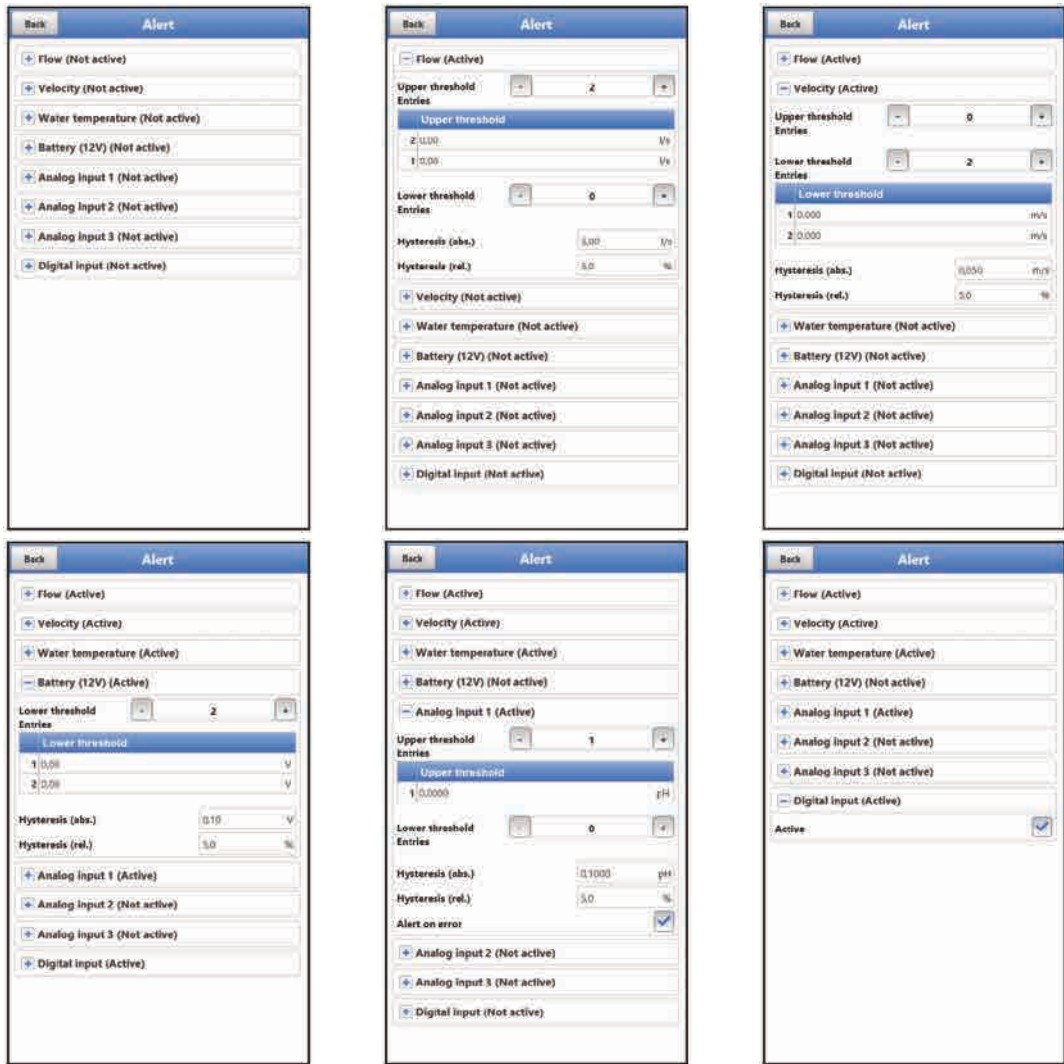

Fig. 37-9 Menu Alert

Depending on the transmitter parameter settings the Alert menu may comprise up to eight subsections: >Flow<, >Velocity<, >Water Temperature<, >Battery (12V)<, >Analog Input 1<, >Analog Input 2<, >Analog Input 3< and >Digital Input<.

Here the top or bottom limit values/thresholds and error messages can be set, which are to be used to trigger an e-mail alarm to a pre-set e-mail address.

38 Parameters Menu Application



Fig. 38-1 Application Menu

The following sections describe the general parameter setting procedures.

Parameters for measurements using wet or clamp-on sensors are set in different ways. The parameter setting procedures for the submenus >Measure Place< and >v-Paths< vary depending on the transit time mode.

Due to this, both submenus will be described separately.

38.1 Menu Measure Place

The >Measure Place< submenu is one of the most relevant basic menus when it comes to setting parameters.

The parameter set of a measurement place contains basic settings for:

- Name of measurement place
- Transit time mode
- Arrangement and number of paths
- Measurement medium and medium temperature
- Type and dimensions of channel profile
- Pipe material (incl. lining)
- Possible solid sediments settings (sludge level)
- Low-flow suppression
- Measurement damping and stability

38.1.1 Name of Measurement Place

This is where you can set the name of the measurement place.

Default setting: "NIVUS1".

The default name is deleted automatically as soon as the first character of the new measurement place name is entered.

- ➡ Type the desired name of the measurement place into the text field and confirm with "Enter". The name will be accepted and is shown in the main screen.

38.1.2 Transit Time Mode

Use >Transit Time Mode< to specify the measurement method. Select from:

- Clamp-On (sensors attached from the outside)
- Wet (installed sensors with direct medium contact)

The appearance of the following menus will vary depending on your choice. In such a case both versions are described in the according section of the respective instruction manual.

Path Arrangement in >Clamp-On< Mode

Clamp-on measurements are set up diametrical. The most common variants are measurements in diagonal direction ("Diametrical \") or as V-Echo ("Diametrical V") (Fig. 38-2).

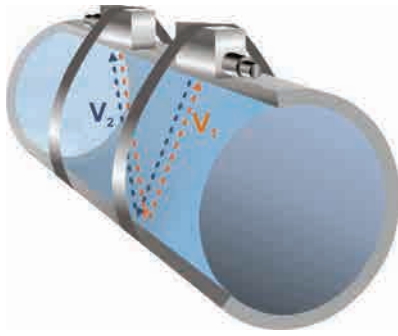

Fig. 38-2 1-Path measurement, path arrangement: "Diametrical V"

Select from:

- Diametrical \
- Diametrical V
- Diametrical VV

Path Arrangement in >Wet< Mode

Measurements with wet sensors can be set up either diametrical or chordal.

Select from:

- Diametrical \
- Diametrical V
- Diametrical VV
- Chordal \
- Chordal V
- Chordal VV
- Chordal X

38.1.3 Number of Paths

In general, the number of paths for NivuFlow Mobile is limited to 2.

Set the number of paths by using "+" and "-". The number is shown in the text field between both symbols.

38.1.4 Medium

Select between “Water” and “User defined”. The “Water” option features fixed properties, while “User defined” requires specifying medium properties such as speed of sound, start, particle entrainment, damping and density when setting parameters.



Fig. 38-3 Selecting the measurement medium



Selecting the measurement medium

Choose “User defined” if your medium to measure is not in the list. This action opens another menu point where you need to specify e.g. the speed of sound within the medium.

Tip:

Lists providing various speeds of sound can be found in the Internet.

38.1.5 Medium Temperature

The medium temperature is required to compute the sensor distance and must be specified as accurate as possible.

38.1.6 Channel Profiles

The NivuFlow Mobile with clamp-on measurement permits to select between “Pipe” and “Rectangular”. “Pipe” is circular, not elliptic.

The selected profile is indicated as a graph in the preview field. The graphic representation, however, does not coincide with the dimensions (in relation) specified. There is **no visual control** available.



Select profile.

The dimensional values are entered as soon as the profile has been chosen.

The unit is set to meter [m] per default. This can be changed in the >System< / >Region Settings< / >Units< / >Level< menu (Fig. 38-4).

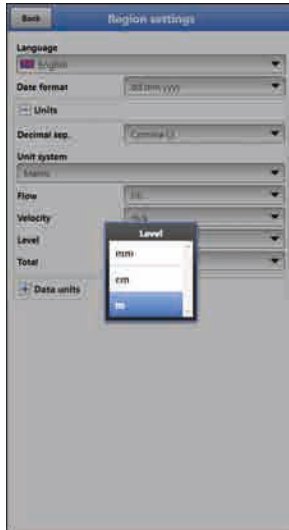

Fig. 38-4 Setting the units

Entering the channel dimensions

For **pipes** it is sufficient to enter two values to specify the pipe dimensions:

- Pipe circumference or inside diameter or outside diameter
- Wall thickness

Entering inside diameter and wall thickness causes the transmitter to add outside diameter and pipe circumference automatically. The same applies once circumference and wall thickness are entered. The transmitter adds the missing parameters.

For **pipes with inner lining** it is necessary to additionally specify the thickness of the lining material. The transmitter includes the material thickness with the calculation and uses it to compute the correct inside diameter.

For **rectangular profiles** width, height and wall thickness are required. If the channel is equipped with a lining the thickness of the lining needs to be specified too.

38.1.7 Wall Material

Different pipe materials feature varying properties regarding the speed of sound.

The most usual pipe materials can be found in the selection menu.

Considering this selection as well as the specified measurement medium the transmitter computes the sound transit time required for the measurement.



Selecting the wall material

If you cannot find the material of the pipe at the measurement place in the list select "User defined". This action opens up another menu point which prompts you to specify e.g. the speed of sound of the pipe material.

Tip:

When it comes to determine the speed of sound within the pipe material contact the pipeline manufacturer.

38.1.8 Lining

In practice, cases occasionally arise in which pipelines are equipped inner linings.

The most usual lining materials can be found in the selection menu.

Considering this selection as well as the specified measurement medium the transmitter computes the sound transit time required for the measurement.



Selecting the lining material

If you cannot find the lining material in the list select "User defined" and contact the pipeline manufacturer for details on the speed of sound within the lining material.

38.1.9 Sludge Level

Depending on measurement medium and flow velocity horizontal pipelines may tend to sedimentation on the pipe bottom.

The >Sludge Level< parameter permits to specify a certain sedimentation level within the pipe. The sedimentation is then considered as "non-moving partial area on the channel bottom with horizontal surface". Prior to computing the flow rate this level height is subtracted from the wetted hydraulic total area.

38.1.10 Low-Flow Suppression

This parameter is used to suppress lowest movements or apparent flow rates. The main area of use is the measurement of discharge volumes in permanently filled constructions.

☞ Check >Active< and enter the desired value in >Q suppressed< or >v suppressed<.

The low-flow suppression disregards the detection of very low flow velocity fluctuations.

- >Q suppressed<
Enter the flow rate as positive value.
Negative values are not possible. The specified value is considered as absolute value and is effective in both positive and negative directions. The measurement system will automatically reset the readings to "0" if the values should be lower than the value specified here.
- >v suppressed<
This parameter permits to suppress apparent flow rates in applications featuring large profiles and high levels. Very low velocity fluctuations may cause heavy apparent flow rate fluctuations over a long period which cannot be suppressed using the >Q suppressed< function. The measurement system will automatically reset the readings to "0" should the flow velocities be lower than the value specified here.
This will set also the calculated volume to "0".
Only positive values can be entered here. The specified value is considered as absolute value and is effective for both positive as well as for negative velocities.

38.1.11 Damping

This menu enables to adjust the display and analog output damping in seconds.

Damping relates to all flow velocity values which are available as input. It is not possible to select individual values and to damp single values in different ways.

Taking the specified period, all readings are saved and a floating average is created for each individual average value. This average is used for further calculation of the flow rate.

Input the value in steps of one second.

Default setting: 30 s

38.1.12 Stability

The stability parameter defines the period the transmitter bridges values without having valid measurement events (e.g. in case of invalid flow velocity readings) available.

During this period the transmitter operates using the latest valid reading. If the specified period is exceeded without detecting a correct value the transmitter goes back to reading "0" considering the damping set. The transmitter does not store the values.

Input the value in steps of one second.

Default setting: 30 s

38.2 Menu v-Paths

The specifications in this menu point refer to the channel as defined in the >Measure Place< menu.

Moreover, this menu permits to enter some specifications required to calculate the sensor positions. In this menu the NivuFlow Mobile shows the sensor mounting distances after the specifications are completed.

The >v-Paths< menu provides tabs for the v-paths 1 and 2 on the top right.

The basic structure applies for all menus, the indicated sensors and values, however, may vary depending on the application.

38.2.1 Sensor Types in >Clamp-On< Transit Time Mode

The same selection of sensors (Fig. 38-5) is available for both v-paths. Select from >Automatic Detection<, >NIC0-K1L<, >NIC-CO01< and >User defined<.

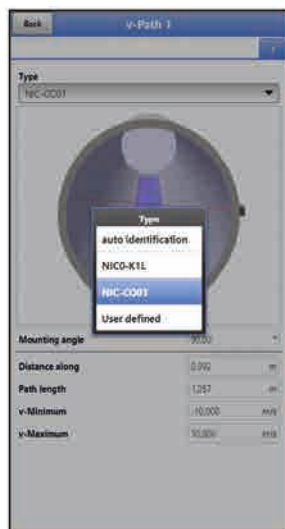

Fig. 38-5 Sensor Selection Menu

☞ Select Sensor Type:

- >Auto Identification<:
The NivuFlow Mobile detects the values without the need to previously select the sensor type; mandatory requirement here is the use of NIVUS sensors however.
- >NIC0-K1L<:
The values for the sensor itself are pre-set and cannot be selected or changed.
- >NIC-CO01<:
The values for the sensor itself are pre-set and cannot be selected or changed.
- >User defined<:
The values for >Angle<, >Frequency<, >Offset< and >Coupling Wedge Speed of Sound< must be specified.

Default setting: Auto Identification

38.2.2 Sensor Types in >Wet< Transit Time Mode

The same selection of sensors (Fig. 38-6) is available for both v-paths. Select from >Auto Identification<, >TSP0V200< and >User defined<.



Fig. 38-6 Sensor Selection Menu

➡ Select Sensor Type:

- >Auto Identification<
The device automatically detects the sensor used and takes over the according data.
- >TSP0V200<:
The values for the TSP0 V200 sensor itself are pre-set and cannot be selected or changed.
- >User defined<:
The values for >Angle<, >Frequency<, >Offset< must be specified.

Default setting: User defined

38.2.3 Sensor Mounting Position

Mounting Angle, Distances and Path Length



Hints on the Mounting Angle

In horizontal pipelines do not use pipe bottom or pipe crown as mounting places (risk of soiling, air bubbles).

NIVUS recommends a mounting angle of 45°.

Set the angle in which the sensors are clamped onto or installed into the pipe here. The mounting angle must be specified for each path separately, all paths, however, must have the same mounting angle.

➡ Procedure to set the sensor parameters:

1. Enter the >Mounting Angle<.

In combination with the measurement place parameters entered so far the transmitter calculates >Distance along< or >Distance across< and the >Path Length<.

These values are read-only values and can be used for sensor fastening. The >Distance along< parameter is the clear distance between both sensors.
 2. Specify >Weighting< and >Hydraulic Factor< if required. The default setting is 100 % or 96 %.
- By modifying the >Weighting< value the involved paths can be weighted and

prioritised differently.

By modifying the >Hydraulic Factor< it is possible to include particular hydraulic conditions prevailing at the measurement place (e.g. to calibrate a measurement place). Upon request NIVUS provides technical support.

- Repeat the previous steps for path 2 in line with path 1.

38.2.4 v-Minimum and v-Maximum

The >v-Minimum< and >v-Maximum< settings define the limit values for the velocity measurement. The transmitter ignores occasional higher and lower velocities which hence will not be shown. Permanently measured deviations are indicated as "0". Only the next realistic readings will be indicated correctly.

Values within a range of -15 to +15 m/s can be set.

Default setting:

- v-Minimum: -10 m/s
- v-Maximum: 10 m/s

38.3 Menu Inputs/Outputs (analog and digital)

This menu is to define the function of the analog as well as digital inputs and outputs. Other parameters such as measurement and output spans, offsets, limit values, error reactions etc. can be set here as well.

- ➡ Open the >Inputs/Outputs< menu from >Main Menu< / >Application<.

The inputs/outputs menu is subdivided into four parts:

- Analog inputs
- Analog outputs
- Digital inputs
- Digital outputs



Fig. 38-7 Inputs/Outputs Menu

38.3.1 Analog Inputs

The transmitter is equipped with three analog inputs. The inputs are indicated in the top right display corner from where they can be selected individually. The selected analog input is highlighted and the clear name is indicated in the headline.

Default setting: Input inactive

Alternatively, the transmitter can be used as an extra data logger for measurement values from external systems or for supply of analog sensors. This, however, does not influence the instrument's capabilities as flow meter.

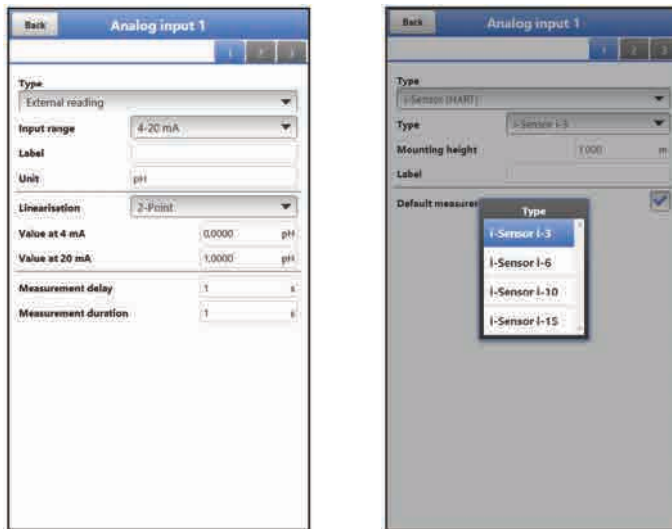

Fig. 38-8 Analog input as external reading / i-series sensor (HART)

The values below must be chosen/entered in **>External Reading<**.

- Selection/Input Options:
 Input Range: >0-20 mA< or >4-20 mA<
 Label: manual input
 Unit: manual input
 Linearisation: >2-Point< or >Table<
 For >2-Point< linearisation: manual input of values for 4 or 20 mA.
 For >Table< linearisation: manual input of the number of >Entries<, then select >Table<, complete and confirm.

The values below must be chosen/entered in **>i-Sensor (HART)<**.

- Selection/Input Options:
 Type: >i-Sensor i-3< or >i-Sensor i-6< or >i-Sensor i-10< or >i-Sensor i-15<
 Mounting height manual input
 Label: manual input
 Default measurement duration: check box; if the box is not checked enter values manually for measurement delay and measurement duration.

38.3.2 Analog Outputs

The transmitter is equipped with one analog output 0-10 V.

Default setting: output inactive

The following different functions can be assigned to the analog output:



Fig. 38-9 Analog output activation

- **Flow**
The application flow rate (calculated from average flow velocity and wetted cross section) is available on the selected analog output.
 - Selection/Input Options:
Output range: >0-5 V< or >0-10 V<
Value at 0 V: manual input
Value at 10 V: manual input
Value at error: >0 V< or >Hold value< or >10 V<
- **Flow Velocity**
The calculated average flow velocity used to compute the current flow rate is available on the selected analog output.
 - Selection/Input Options:
Output range: >0-5 V< or >0-10 V<
Value at 0 V: manual input
Value at 10 V: manual input
Value at error: >0 V< or >Hold value< or >10 V<
- **Water Temperature**
The medium temperature calculated based on the transit times is available on the selected analog output.
 - Selection/Input Options:
Output range: >0-5 V< or >0-10 V<
Value at 0 V: manual input
Value at 10 V: manual input
Value at error: >0 V< or >Hold value< or >10 V<
- **External Reading**
Possibly linearised measurement values available at the analog input are available here.
 - Selection/Input Options:
Analog input: >Input 1< or >Input 2< or >Input 3<
Output range: >0-5 V< or >0-10 V<
Value at 10 V: manual input
Value at error: >0 V< or >Hold value< or >10 V<
- **Path Velocity**
If more than one flow velocity sensor is used and if the average flow velocity of the individual measurement paths is to be determined it is possible to select the desired flow velocity sensor and to output the according measurement value.

- Selection/Input Options:
v-Path: >Path 1< or >Path 2<, depending on the number of connected path
Output range: >0-5 V< or >0-10 V<
Value at 0 V: manual input
Value at 10 V: manual input
Value at error: >0 V< or >Hold value< or >10 V<

38.3.3 Digital Inputs

The transmitter is equipped with one digital input.

Default setting: Input inactive

The following different functions can be assigned to the digital input.



Fig. 38-10 Digital input activation

- **Run Times**
The system detects and saves the duration of the ongoing signal at the digital input. Such records are used to gather information e.g. on pump run times or other equipment run times.
 - Selection/Input Options:
Logic: >not inverted< or >inverted<
Label: manual input
- **Impulse Counter**
The system counts and saves the number of ongoing signals at the digital input. The counter simply counts the status changes detected at the digital input (1->0 or 0->1).
 - Selection/Input Options:
Edge:
>rising< (status change from "0" to "1") or
>falling< (status change from "1" to "0")
Label: manual input
- **Logging**
Logging of readings and the according status changes for diagnostic purposes. Evaluation is carried out by detecting the status changes of the digital input (1->0 or 0->1).
 - Selection/Input Options:
Logic: >not inverted< or >inverted<
Label: manual input

38.3.4 Digital Outputs

The transmitter is equipped with one digital output.

Default setting: output inactive

The following different functions can be assigned to the digital output.

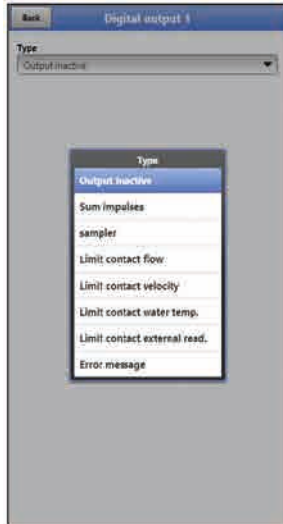

Fig. 38-11 Digital output activation

- **Sum Impulses**
Output of flow-proportional sum impulses.
 - Selection/Input Options:
Logic: >Normally open< or >Normally closed<
Negative sum impulses: check box
Quantity: manual input
Duration: manual input
- **Sampler**
In connection with a sampler provided by the customer it is possible to define the according cyclic control.
 - Selection/Input Options:
Logic: >Normally open< or >Normally closed<
Level: manual input
Volume: manual input
Duration: manual input
- **Limit Contact Flow**
Exceeding the >Threshold on< value will output a digital signal, falling below >Threshold off< will reset the digital signal = hysteresis function to avoid output flutter.
 - Selection/Input Options:
Logic: >Normally open< or >Normally closed<
Threshold on: manual input
Threshold off: manual input
Value at error: >Off< or >On< or >Hold Value<
- **Limit Contact Velocity**
Exceeding the >Threshold on< value will output a digital signal, falling below >Threshold off< will reset the digital signal = hysteresis function to avoid output flutter. The calculated average flow velocity (calculated even from multiple paths) is used.
 - Selection/Input Options:
Logic: >Normally open< or >Normally closed<
Threshold on: manual input
Threshold off: manual input
Value at error: >Off< or >On< or >Hold Value<

- **Limit Contact Water Temperature**
Exceeding the >Threshold on< value will output a digital signal, falling below >Threshold off< will reset the digital signal = hysteresis function to avoid output flutter.
 - Selection/Input Options:
Logic: >Normally open< or >Normally closed<
Threshold on: manual input
Threshold off: manual input
Value at error: >Off< or >On< or >Hold Value<
- **Limit Contact External Reading**
Exceeding the >Threshold on< value will output a digital signal, falling below >Threshold off< will reset the digital signal = hysteresis function to avoid output flutter.
 - Selection/Input Options:
Logic: >Normally open< or >Normally closed<
Analog input: >Input 1< or >Input 2< or >Input 3<
Threshold on: manual input
Threshold off: manual input
Value at error: >Off< or >On< or >Hold Value<
- **Error Message**
By activating individual selection fields (check box) it is possible to assign individual error types to the digital output. Moreover the output logic can be switched between normally open and normally closed.
 - Selection/Input Options:
Logic: >Normally open< or >Normally closed<
v-Measurement: Check box
h-Measurement: Check box
T-Measurement: Check box
External value: Check box
System: Check box

38.4 Diagnostics Menu

The Diagnostics menu is described separately in greater detail in chapter “Diagnostics” starting at page 119 of the instruction manual.

39 Parameter Menu Data



Fig. 39-1 Data Menu

39.1 Trend

The Trend graph is a representational recorder function. Choosing the trend graph provides access to current and previously saved (historic) measurement data.

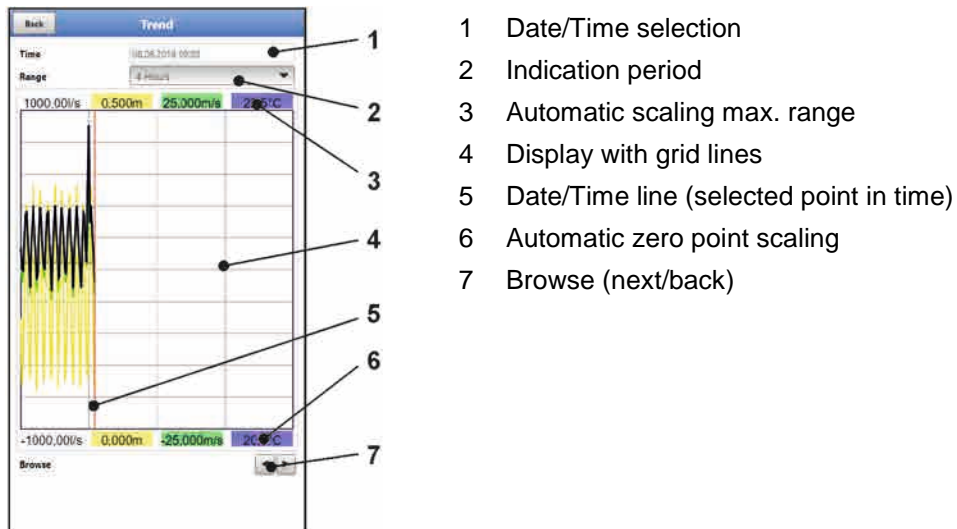

Fig. 39-2 Trend Graph Details

Current Measurement Data

➡ Procedure to view current measurement data:

1. Select the desired range (indication period; Fig. 39-2 no. 2).
The selected range will be indicated. The measurement data will not be automatically updated during indication.
2. Use the arrows (Fig. 39-2 no. 7) to browse next or back if required leaving the basic display settings unaltered.
3. Use "Back" to go back to the main screen.

>Selecting Time/Date<

Opening the Trend menu shows the current date and time. If you wish to view historic readings/a particular point in time select the desired period from the Date/time selection screen (Fig. 39-2 no. 1). Here the selection mask below opens up (Fig. 39-3). The readings are indicated (depending on the period set) in the subsequent screen once a start date is selected.

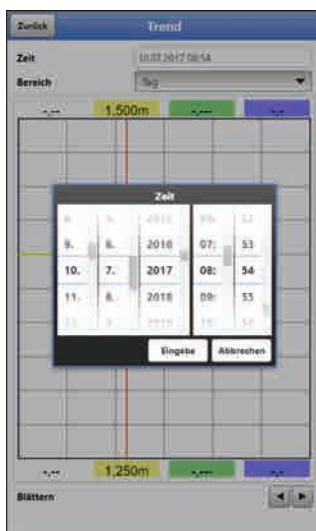

Fig. 39-3 Selecting Time/Date

>Range (Indication Period)<

The range selection determines the period to indicate on the screen.

Selection	Representation on the display		
	Left Margin	Right Margin	Grid Lines
Hour	0 minutes	59 minutes	15 minutes each
4 Hours	0/4/8/12/16/20 o'clock, depending on the time set	4 hours later	1 hour each
Day	0 o'clock	24 o'clock	4 hours each
Week	Monday, 0 o'clock	Sunday, 24 o'clock	1 day each
4 Weeks	Monday, 0 o'clock	4 weeks later, Sunday, 24 o'clock	1 week each; start reference time: 29.12.1969, 0 o'clock

Table 5 Remarks to the periods displayed

39.2 Day Totals

The table below shows the flow rate totals taken in the last 24 hours.

Date	Total
1.12.2019 00:00:00	0.000
2.12.2019 00:00:00	0.500
3.12.2019 00:00:00	0.000
4.12.2019 00:00:00	0.000
5.12.2019 00:00:00	0.500
6.12.2019 00:00:00	0.000
7.12.2019 00:00:00	0.000
8.12.2019 00:00:00	0.000
9.12.2019 00:00:00	0.000
10.12.2019 00:00:00	0.000
11.12.2019 00:00:00	0.500
12.12.2019 00:00:00	0.000
13.12.2019 00:00:00	0.000
14.12.2019 00:00:00	0.000
15.12.2019 00:00:00	0.000
16.12.2019 00:00:00	0.500
17.12.2019 00:00:00	0.000
18.12.2019 00:00:00	0.000
19.12.2019 00:00:00	0.500
20.12.2019 00:00:00	0.000
21.12.2019 00:00:00	0.000
22.12.2019 00:00:00	0.500
23.12.2019 00:00:00	0.000

Fig. 39-4 Selection Day Totals

Up to 100 totals (= 100 days) are saved. Starting with the 101st value the oldest value will be overwritten (ring memory).

A **prerequisite** to indicate older values is that the instrument has been running for a longer period.

Example: 98 values – the unit has completed 98 totalising processes, so it must be running for at least 98 days.

In general, only day totals can be viewed which have been created while the instrument was actually in operation.

As soon as the NivuFlow Mobile is shut down between two totalising events (<24 hours) the transmitter creates a total using **measured** values. Such totals are **not equal to the actual day total** but reflect the total measured by the transmitter while being in operation.

As soon as the transmitter is shut down before the next totalising event and remains to be off until the next totalising (>24 hours) no totals will be created for this period (Fig. 39-5 no. 2). No data will be stored and no name will be created for this period. This “gap” can be identified from the completely missing entry (date/values) within the listed sequence. **No empty lines** will be created.

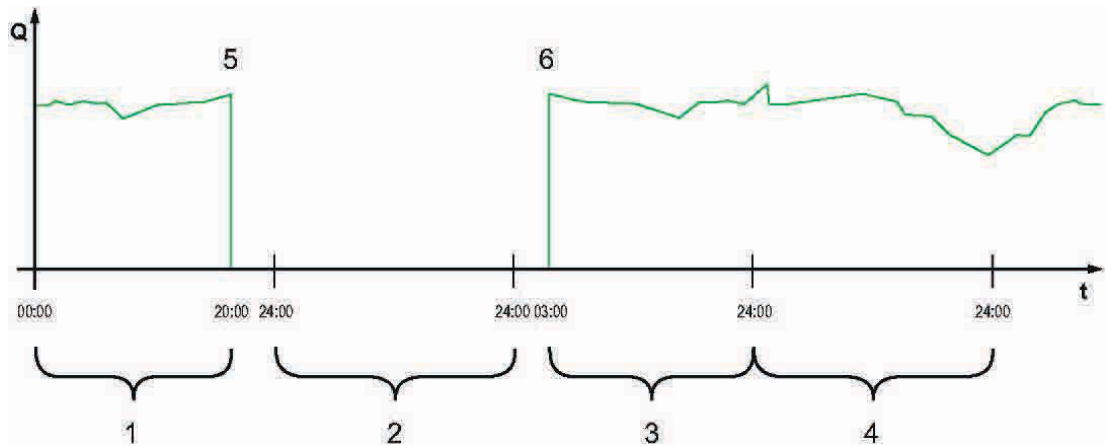

- 1 Total Day 1: Total covering 20 hours
- 2 Day 2: Power failure – no totalising
- 3 Total Day 3: Total covering 21 hours
- 4 Total Day 4: Total covering 24 hours
- 5 Power failure
- 6 Power available again

Fig. 39-5 Totalising scheme

- Per **default** the **totalising period** is between 00:00 o'clock and 24:00 o'clock. This means that day totals are always created between 00:00 o'clock and 24:00 o'clock.
- The **default totalising time** is at 00:00 o'clock.

The totalising time can be modified using >Update (Time)< (Fig. 39-6). Once modified, the totalising will start at the time set and stops 24 hours later.



Fig. 39-6 Updating the totalising time

The value shown in >Current< is the subtotal since the last totalising.

39.3 Data Memory

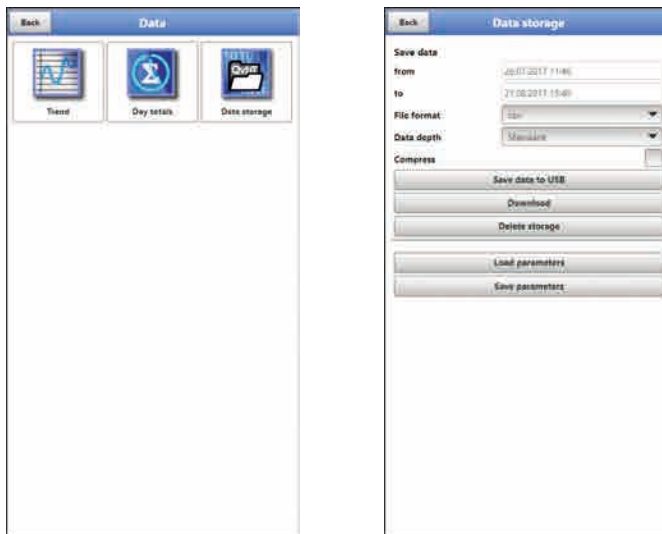

Fig. 39-7 Data Memory Menu

The NivuFlow has an internal data memory (max. 182,398 measurement cycles, more cycles will start overwriting). It is possible to transfer either portions of your data or all saved readings to an USB stick.



Using the USB interface is allowed only outside of Ex areas.

USB Stick Requirements

- Supports USB 2.0
- FAT 32 (or FAT 12 or FAT 16) formatted
- Max. permissible capacity 32 GB

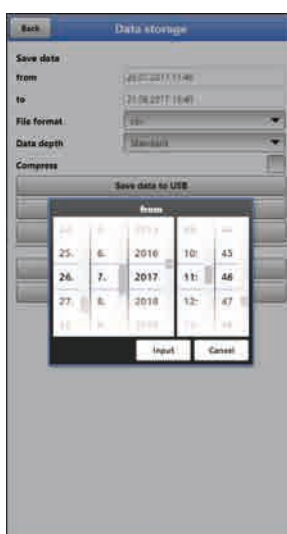

Fig. 39-8 Specify Start/End time

- **>from< / >to<**
This section allows you to determine the desired transmission period. Define the period in some kind of calendar (Fig. 39-8).

Per default the transmitter is set as to transmit the data containing the period between the latest previous transmission and the current time.

- **>File Format<**
>csv< or >txt<
- **>Data Depth<**
Data depth is subdivided into four sections:
 - **>Standard<**
This is the appropriate format for the most applications and hence is the default setting.
The saved data sets contain the following information:
 - Date and time
 - Totaliser
 - Calculated flow rate
 - Average flow velocity
 - Water temperature
 - Current values as well as the accordingly calculated values of enabled analog and digital inputs
 - Battery voltage
 - NFM power consumption
 - **>Extended<**
This option is appropriate for the verification of critical, important applications and is required mainly for servicing personnel.
The saved data sets contain the following information:
 - All data sets from the previous data depth >Standard<
 - Average flow velocities of v-Paths 1 and 2 (if used)
 - **>Expert<**
This option should be used only by trained service personnel or the NIVUS GmbH developers. Such data sets may become very large very quickly. If required contact NIVUS.
 - **>Day Totals<**
This option saves only the day totals, no individual values.
- **>Compress<**
This function is useful to transmit large data sets. In this case the selected files are zipped as ".zip" files.
- **>Save Data to USB<**
This function permits to save measurement data covering a previously determined period to USB stick.
- **>Download<**
Use this function to save measurement data covering a previously determined period to the operating unit (smartphone, tablet, notebook etc.).
- **>Delete Storage<**
This function can be used to completely erase the internal data memory. Selecting this option will prompt you to confirm. After confirmation with >Yes< the data will be erased, >No< will abort the process.
- **>Load Parameters<**
Use this function to load a parameter file previously saved to USB stick or the operating module back to the transmitter again.
- **>Save Parameters<**
The measurement place parameter sets can be saved to USB stick here. Only two files with the formats below will be created and saved:
 - **XXXX_DOC_AABBCCDDEE.pdf**
This file is for documentation purposes and contains basic settings as well as parameter changes.

- **XXXX_PAR_AABBCCDDEE.xml**
This file contains the entire transmitter parameter settings and is used as backup of the current parameter settings.

Remarks on file names:

XXXX = Name of the measurement place set

AA = Year

BB = Month

CC = Day

DD = Hour

EE = Minute

40 Parameter Menu System

40.1 Information

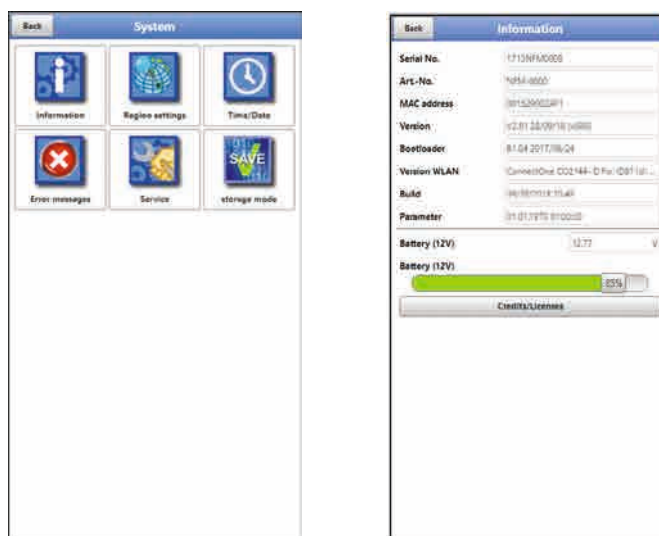

Fig. 40-1 System - Information - Menu

>Information< is a read-only menu and provides the instrument information below:

- Serial no. and article no.
- MAC address
- Firmware version of the transmitter
- Data on boot loader and WLAN version
- Date of the latest software update (firmware) and the last storage of the parameter sets
- Current battery charging status (when using two batteries the battery with the higher capacity is used until the capacity of both batteries has reached the same level; after that both batteries are discharged equally)
- Information on credits and licenses

40.2 Region Settings

The following settings can be configured here:

- (Operation) Language
- Date format
- Units for measurement values
Here it is possible to distinct between stored and displayed measurement values.

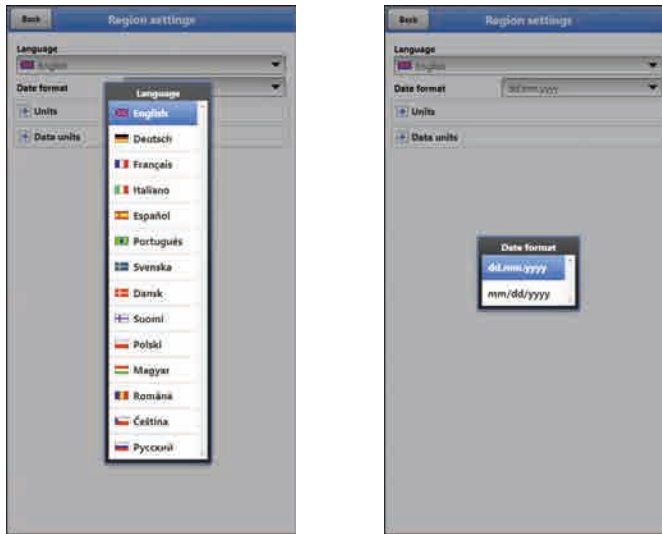

Fig. 40-2 Region Settings – Language – Date Format

40.2.1 (Operation) Language

All listed languages (Fig. 40-2) either contain wordings in the according language or alternatively in English.

40.2.2 Date Format

The date formats below can be set:

- DD.MM.YYYY (Day/Month/Year)
- MM/DD/YYYY (Month/Day/Year)

40.2.3 Units

This menu can be used to adjust various country-specific and unit-specific settings for the indication of measurement values.

>Decimal Separators<

- Comma or Point

The decimal separators specified here are used only for representation on the operation module display.

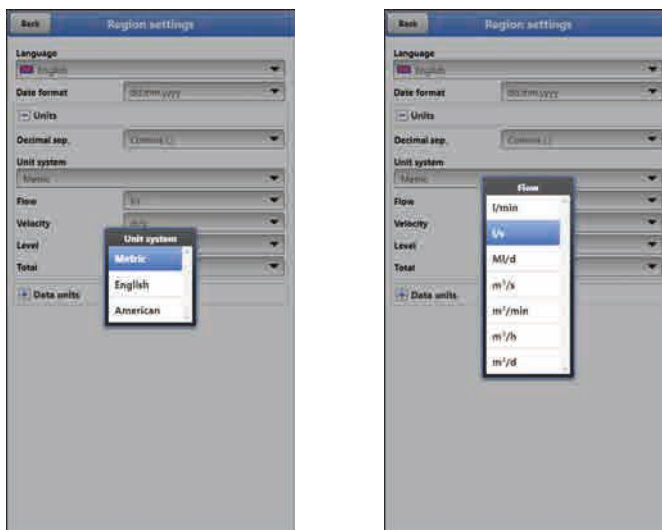

Fig. 40-3 Unit System

>Unit System<

Select from:

- Metric
- English
- American

The **adjustable units** depend on the previously chosen unit system:

- Metric system: l, m³, cm/s etc.
- English system: ft, in, gal/s etc.
- American system: fps, mgd etc.

Units for Display Representation

- Flow
- Flow Velocity
- Level
- Total
- Temperature (for units system “English” only)

40.2.4 Data Units

The >Data Units< settings are in line with the >Units< settings.

In >Data Units< the measurement values are **converted and saved** according to the selected units.



Fig. 40-4 Data Units

>Decimal Separators<

- Comma
- Point

Specifying the decimal separators is relevant for correct data import. Particularly in case of using foreign software applications (such as foreign Excel) to evaluate readings observe to specify the correct decimal separators.

>CSV Separators<

- Comma (,)
- Semicolon (;)

This selection determines how to separate individual data within the .csv-file on readout.

Units for storage

- Metric system: l/s, m³/s, m³/d, cm/s etc.
- English system: ft³/s, in, gal/min, Mgal/d, in/s, yd/s etc.
- American system: gps, gpm, cfs, cfm, cfh, cfd, mgd etc.

Units for the storage of measurement values

- Flow
- Flow Velocity
- Level
- Total
- Temperature (for units system “English” only)

40.3 Time/Date

This submenu allows you to modify the current date and the transmitter system time. The system time is based on the coordinated universal time UTC (French: “Temps universel coordonné”) with “Plus-Hours” or “Minus-Hours” symbols defining the time zones compared to UTC.

NIVUS highly recommend to leave the transmitter system time unchanged and to define your time zone as well as summer and winter times by using the >Time Zone (UTC)< function.

Use >Sync Time/Date< to synchronise date and system time automatically with the display and operation module.

Modifications in the >Time/Date< menu may be necessary to switch from summer time to winter time, due to internal buffer battery failure or after power failure.

The internal clock may deviate when the transmitter has been operated for a long time. Such deviations can be corrected here.



Effects of changing the system time

Changing the system time has an effect on the storage of data. If the data storage option is enabled, duplicate data or data gaps may occur after the system time has been modified.

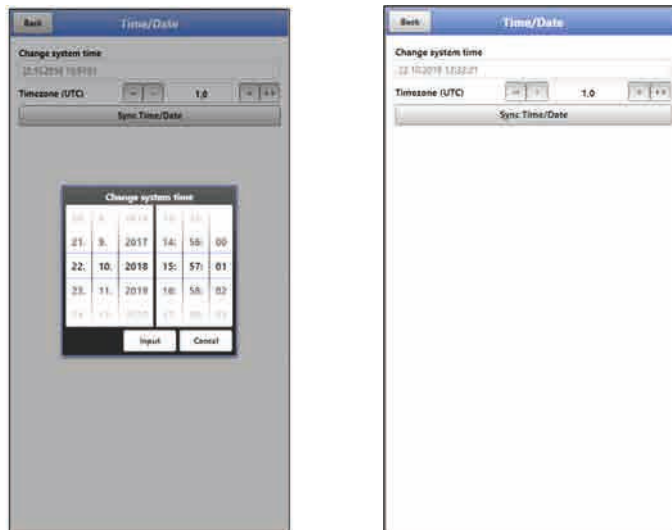

Fig. 40-5 Change system time: manually and automatically

The current system time can be set in the menu above (Fig. 40-5).

Set the time difference (UTC or GMT) to the prime meridian with “+” and “-”:

- = decrease by 1 hour each
- = decrease by ½ hour each
- + = increase by ½ hour each
- ++ = increase by 1 hour each

40.4 Error Messages

Use this menu to recall the currently active queued error messages and to erase the error message memory.

The content of the error memory will be instantly erased by choosing >Erase Error Memory<, no security prompt will come up.

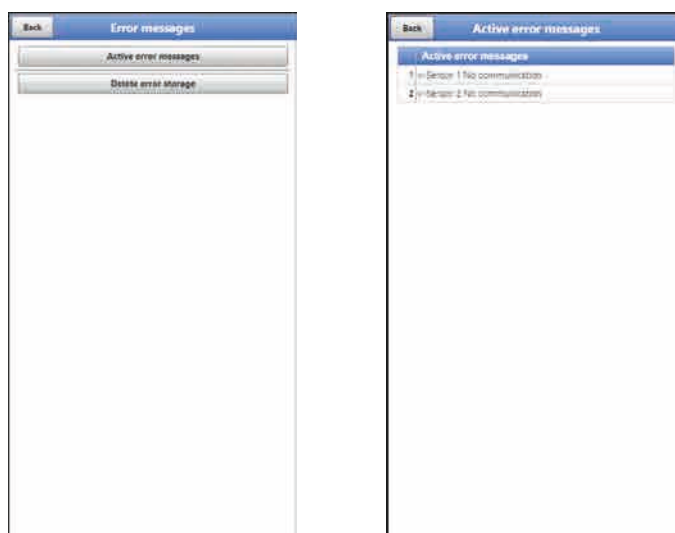

Fig. 40-6 Error Messages

40.5 Service

This submenu contains the following functions:

- Service levels (password-protected); the service levels are reserved exclusively for NIVUS service personnel

- Restart (of system)
- Powerdown (transmitter goes to energy saving mode)
- Parameter reset (back to default settings)
- Feature unlock
- Update NivuFlow
- Update Bootloader



Fig. 40-7 Service

40.5.1 Service Level

The service levels are split into different, accordingly password-protected access levels.

The possible settings as well as the information available here require comprehensive expert knowledge and are not needed for standard applications. This is why the service level is reserved for NIVUS service personnel exclusively.

40.5.2 Restart

A transmitter restart interrupts the current measuring process.

The system will boot using the parameters previously set (saved). After the boot process the system behaves as if being switched on (analog to a PC).

This menu point saves you from shutting down and restarting the system. All saved parameters, counters and data will be preserved.

40.5.3 Powerdown

The >Powerdown< function switches the transmitter to energy saving mode. The instrument will not resume measuring before it has been “woken up”.

40.5.4 Parameter Reset

A parameter reset will reset all parameters to default settings. Counter readings, modified passwords and saved measurement data are preserved.

The parameters will not be actually reset before you exit the service menu (back to main menu) and confirm the storage process. At this point you can still abort the reset.

40.5.5 Feature unlock

Use Feature Unlock to unlock special functions (optional) if ordered from NIVUS.

Functional description

Remote data transmission with NivuFlow Mobile devices can be carried out using different channels. The options below are basically available:

- via MQTT to the NIVUS WebPortal or to a customer system
- via FTP to the NIVUS data portal D2W or to a customer FTP server
- via E-Mail to a preset address



Fig. 40-8 Communications menu

The basic version of all NivuFlow Mobile units is supplied featuring “MQTT Data Transmission”. This feature is activated automatically and is available instantly after initial start-up once the according parameters have been set.

Data transmission via FTP and E-Mail is available as combined extra licence and can be purchased either when placing the order or later at any time.

The link to the NIVUS WebPortal (for licence activation) is sent after the dispatch of the ordered device or subsequently to ordering the licence later via E-Mail to the customer or to the responsible local representative ^{*1)}. Activation must be carried out manually by the user ^{*1)} (see chapt. “Licence activation”). Once the parameters on the NivuFlow Mobile have been set accordingly the data transmission option can be selected and the transmission can be initiated.



To set the parameters refer to chap. 41 Parameter Menu Communication (for the example described).

One licence is valid for **one device** and is assigned permanently to this device by using the **serial number**.

^{*1)} *Depending on the recipient's country the responsible local representative will activate the licence already prior to the dispatch of the device; all ordered features are then available for customers instantly.*

Licence activation



Procedure to **order the device with licence** “FTP/E-Mail Data Transmission” (example):

1. Order NivuFlow Mobile device(s) including the according data transmission licence(s).

This triggers internal processes at NIVUS regarding the production of the NFM device as well as licencing.

2. After receiving the NFM device(s) log in with the NIVUS WebPortal and open the "Licences" tab.
The login data have been transmitted by NIVUS to an E-Mail address as previously agreed.



Licence assignment to device cannot be changed after licencing

One licence is valid for one device only and is assigned permanently to this device by using the serial number. The assignment **cannot be undone** or **changed**.

Prior to assignment check carefully which unit is to be assigned with which licence to ensure correct licencing and to make sure that the desired features can be used with the correct device.

3. The available NFM device(s) is/are listed in the NIVUS WebPortal. The right display field indicates the ordered licences which need to be assigned to the devices by using the serial number.
To do so click the desired licence and select "Activate".
This action removes the selected licence from the right display field while the according device shows the assigned licence number including the activation code. This activation code is required subsequently (once) to set the parameters of the individual devices.
4. For more licences proceed accordingly.
5. Log out from NIVUS WebPortal and exit the application.

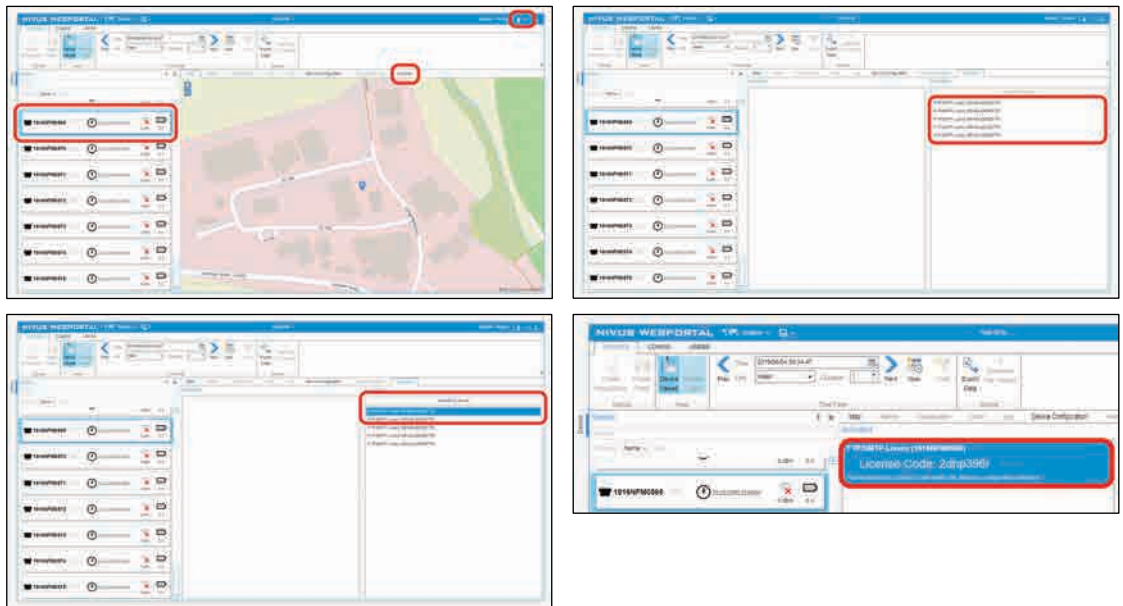

Fig. 40-9 Licence activation in NFM display tool

6. Open the display and operating module (Smartphone, Tablet, Notebook, PC etc.) of the desired NFM and select >Feature unlock< (Fig. 40-10) in the service menu (see also the device's instruction manual).
7. Click button >Feature unlock<.
8. Enter the according activation code and confirm with "Input".
The assigned licence will be shown in the display.



Fig. 40-10 Licence activation in NFM display tool

9. The NFM confirms the activation and prompts a restart of the device. In communication GPRS menu the option to transmit data via FTP / E-Mail is now available.
10. Select/input parameters in >Communication< menu and save.



Fig. 40-11 Restart of the system after feature unlock

- ➡ Procedure for **ordering the „FTP/E-Mail Data Transmission“ licence later:**
1. Place your order for the desired data transmission licence(s) to trigger internal processes at NIVUS regarding licence activation.
 2. After receiving the login data log in with the NIVUS WebPortal and open the “Licences” tab.
The login data have been transmitted by NIVUS to an E-Mail address as previously agreed.
 3. Proceed with step 3 as described in “Procedure to **order the device** with licence “FTP/E-Mail Data Transmission”.
Also observe the important note on “Licence assignment” on page 98 necessarily.

40.5.6 Update NivuFlow

Upload of a NivuFlow Mobile firmware saved on USB.

40.5.7 Update Bootloader

Upload of a bootloader software saved on USB.

40.6 Storage Mode

The >Storage Mode< menu determines the >Operating Mode< and the >Storage Cycle<.

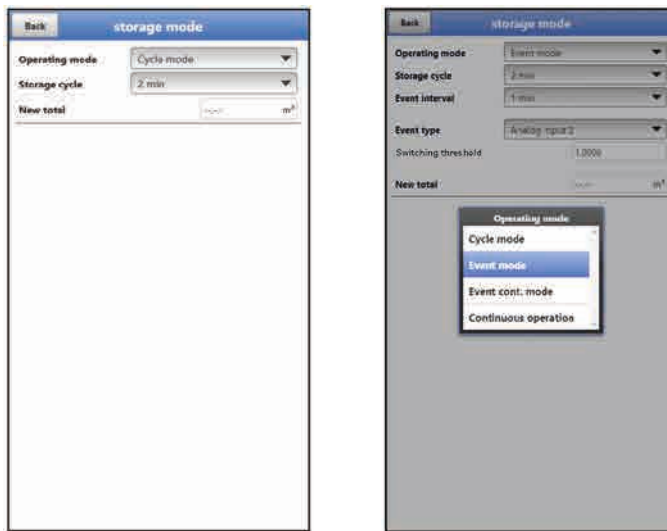

Fig. 40-12 Storage Mode – Operating Mode

Operating Mode, Storage Cycle, Event Type and Event Interval

The operation mode determines when and how often the transmitter shall measure and when and how often the measurements shall be saved. Storage cycle and event interval can be adjusted depending on the operation mode.

To choose the >Operation Mode< select from

- **>Cycle Mode<**
The transmitter wakes up at the intervals set in storage cycle, executes a brief measurement and saves the data. After that the transmitter goes back to “sleep mode” until the next measurement.
- **>Event Mode<**
On one hand, the transmitter behaves like being in cyclic operation, however it is possible to additionally set an event interval. The transmitter then wakes up at previously defined events, measures and saves data at the adjusted event intervals.
- **>Continuous Event Mode<**
In this mode the transmitter basically operates like being event operation, however measures continuously during the event. The instrument saves the data at the adjusted event intervals.
- **>Continuous Operation<**
The transmitter measures continuously, however will save the data only at the intervals set with the storage cycle.

>Storage Cycle<

Select from (depending on the operation mode set): (5 s, 10 s, 20 s, 30 s,) 1 min, 2 min, 5 min, 10 min, 30 min and 1 h

>Event Type< (only with Event mode and Continuous event mode)

The operation modes “Event mode” and “Continuous event mode” allow to (depending on the parameters) additionally select the event types “Flow”, “Velocity”, “Water temperature”, “Analog input 1”, “Analog input 2”, “Analog input 3” and “Digital input 1”.

Use “Flow”, “Velocity” and “Water temperature” to determine the switchover threshold.

The indicated selection of event types varies depending on the parameter settings.

>Event Interval<

Available settings: 1 min, 2 min and 5 min

>New total<

Here either the flow rate can be reset to "0" or a new (basic) value for the flow rate can be set. This may become necessary after transmitter replacement or as soon as the parameters for a new measurement place need to be adjusted.

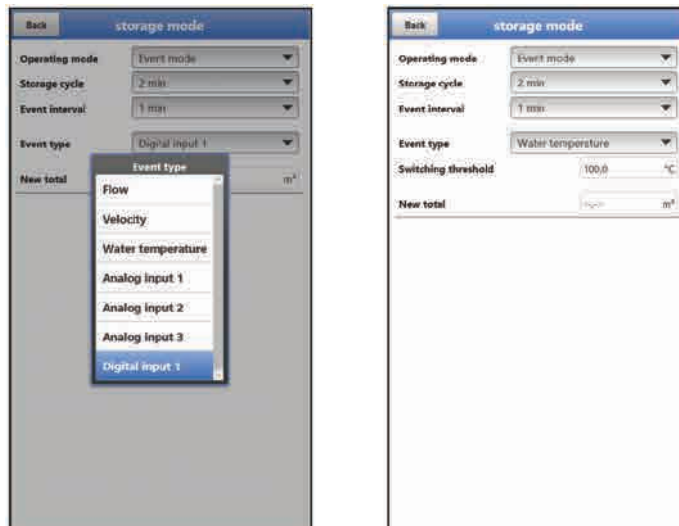

Fig. 40-13 Event types

41 Parameter Menu Communication

This menu is used to set up communication with the display and operation module (smartphone, tablet, notebook etc.) or other devices.

The transmitter communicates via WLAN and GPRS.

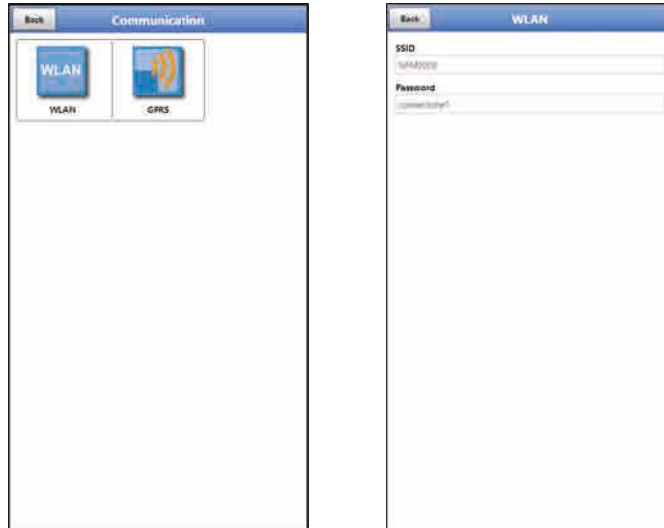

Fig. 41-1 Menu - Communication

The **>WLAN<** menu provides information on SSID and the WLAN password. This is a read-only menu.

➡ To change the WLAN password see chapter “35.2 Change WLAN Password”.

Prepare the device for data transmission

Use the button **>Start data transmission<** to cause the NivuFlow Mobile to transmit data to the NIVUS Web Portal where the data can be selected/shown. To indicate the according measurement place correctly on the overview map in the NIVUS Web Portal featuring the respective GPS coordinates it is necessary to correctly set these specifications once. There is no automatic update during measurement operation.

Precondition

The device shall be positioned so as to have an unobstructed view to the sky, i. e. best before being located within a shaft or a room.

➡ Procedure

1. Start the modem under **>Modem state<**.
2. Wait until the device has found and entered the correct GPS coordinates (latitude/longitude) in the menu (see Fig. 41-3). This may take up to several minutes.
The measurement place will be not correctly indicated in the NIVUS Web Portal overview map without the GPS coordinates. In any event, data will be assigned to the right measurement place, however.
3. Use the **>Start data transmission** button to transmit data once and to make sure that the connection has been set up successfully and GPS coordinates are transmitted.
Then the NivuFlow Mobile can be positioned in its planned installation place.

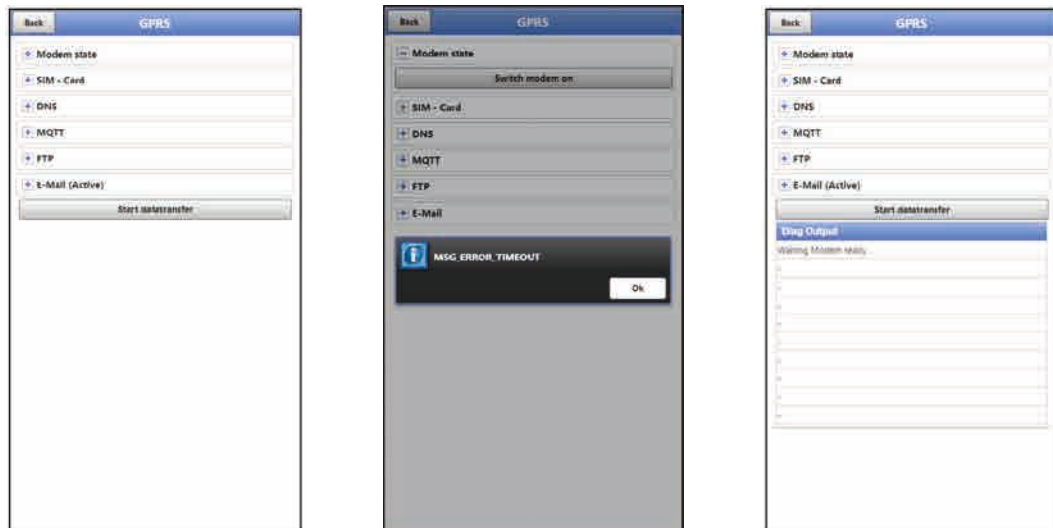

Fig. 41-2 GPRS menu / Modem error message / Diag Output

Set up and adjust the data remote transmission in the >GPRS< menu.

After **inserting the SIM card** the following submenus can be used. Without the SIM card the message “ERROR” or “MSG_ERROR_TIMEOUT” is shown and an according message is indicated in >Diag Output< too.

- **>Modem state<**
 - **>Switch modem on<**: Modem and SIM are initialised and current network status is displayed (signal strength, data transmission standard, frequency band and operator).
 - **>Test connection<**: A test connection can be set up after a successful start. During this procedure >Diag Output< indicates a current status info.

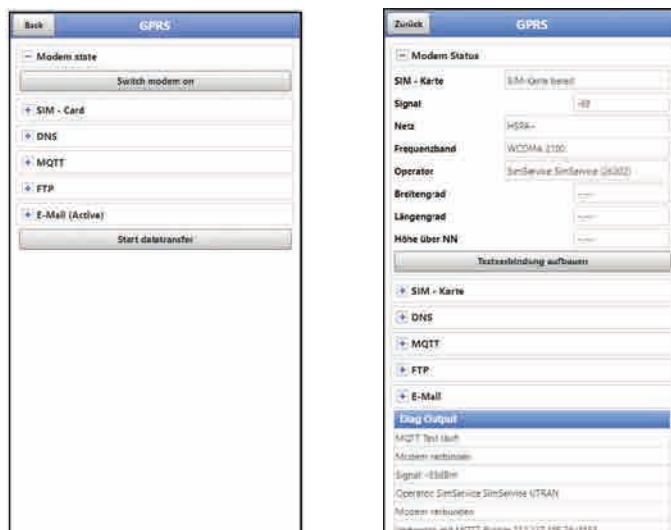

Fig. 41-3 Modem state / SIM-Card state

- **>SIM-Card<**
 - **>Get state<**: The PIN verification status is queried and indicated.
 - Enter the according PIN as soon as the PIN check is active.
 - The field may be left empty if the PIN check is not active.
 - **>Activate pin check<**:
 - To activate enter the PIN and select >Change Pin<.
 - To change the PIN with the PIN check active enter the new PIN and then select >Change Pin<.

- If the PIN is entered incorrectly three times, the value must be entered using the SIM-card PUK and a new PIN needs to be specified.

- **>Provider<**: selection of providers; available are T-Mobile Deutschland, Vodafone, O2, NIVUS and User defined; If user defined is selected enter the provider access data: APN (Access Point Name) and, if required, user name, password and IP address.

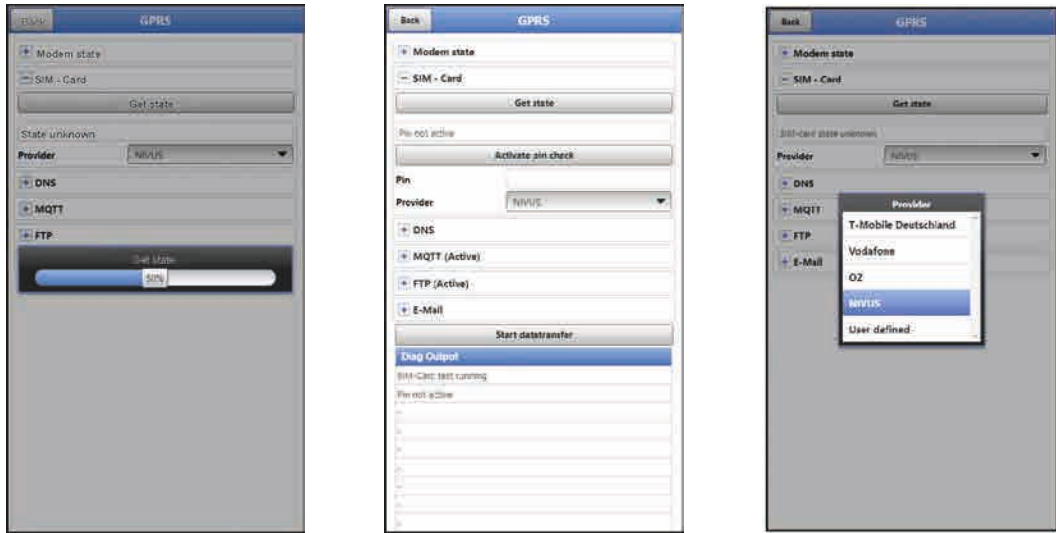

Fig. 41-4 SIM-Card

- **>DNS<**: Names will be normally assigned automatically (default setting); if the provider requires a certain DNS please enter accordingly.

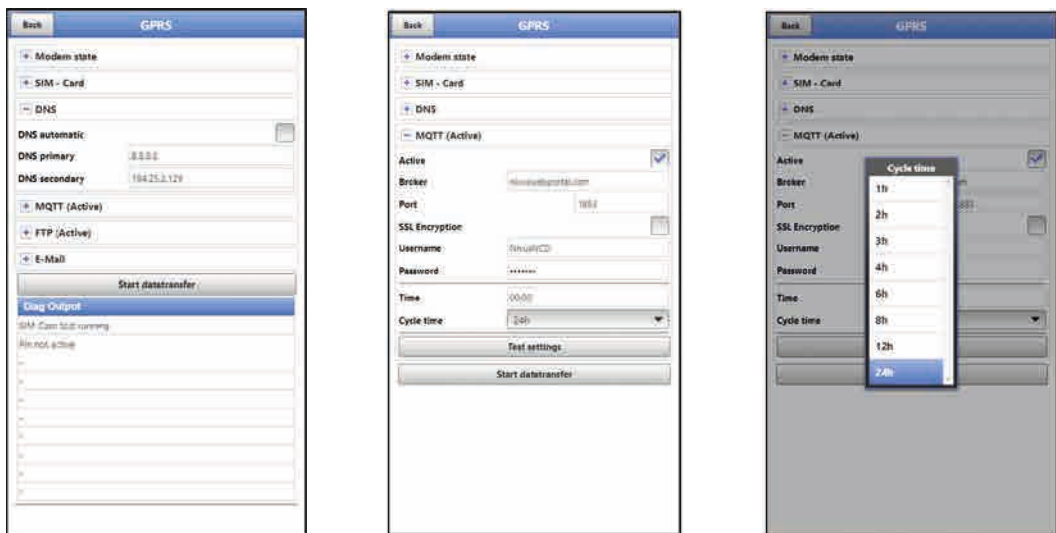

Fig. 41-5 DNS / MQTT

Default setting: Transmission to Nivus Web portal (MQTT).

Access data can be requested from NIVUS via E-Mail.

If you wish to use a transmission option other than the pre-set option (>FTP< or >E-Mail<), the MQTT transmission must be deactivated first and then the alternative must be activated.

- **>MQTT<**: Transmission to NIVUS web portal; alternatively the MQTT protocol can be used to set up a direct connection to customer systems, in such cases contact the NIVUS customer centre.

- Check the according box if the transmission shall be executed via MQTT. The settings for transmission to the NIVUS Web Portal are preconfigured.
- **>Time<**: Specify the time of daily transmission.
- **>Cycle time<**: Set the transmission cycle in hours (1, 2, 3, 4, 6, 8, 12 or 24h).
- **>Test settings<**: Use this menu to verify the settings, the results can be viewed in >Diag Output<.
- **>Start Data Transmission<**: Data (error information, archived data and current values) is transmitted, the result is issued on >Diag Output<.



Follow the procedure described in “Prepare the device for data transmission” on page 102.

- **>FTP<**

Transmission to customer FTP server or to D2W data portal.

- For transmission to FTP server check the according box.
- **>Server<**: Enter server name or IP.
- **>Port<**: Enter FTP-Port (standard 21).
- SSL encryption can be selected optionally.
- **>Authentication<**: Activate if the FTP access is user and password protected and specify user as well as password.
- **>Destination folder<**: Specify the destination directory where files are to be saved.
- **>Device to Web<**: Activate in case of transmission to D2W; a format compatible to Device to Web will be used.
- **>File format<**: Available formats are csv and txt.
- **>Data<**: Specify the data depth to transmit (Standard, Extended and Expert) (see chapter “39.3 Data Memory”).
- **>Time<**: Specify the time of regular transmissions; the time specified serves as start time for the cyclic transmissions.
- **>Cycle time<**: Set the transmission cycle in hours (1, 2, 3, 4, 6, 8, 12 or 24h).
- **>Test settings<**: Use this menu to verify the settings, the results can be viewed in >Diag Output<.
- **>Start Data Transmission<**: Data (error information, archived data and current values) is transmitted, the result is issued on >Diag Output<.



Follow the procedure described in “Prepare the device for data transmission” on page 102.

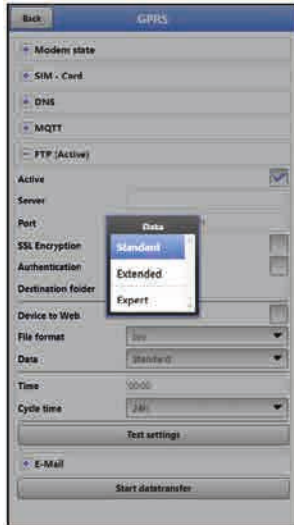

Fig. 41-6 FTP / E-Mail

- **>E-Mail<**

Transmission to e-mail address.

The access data >SMTP server<, >User name< and >Password< are available from your e-mail provider.

- Check the according box for transmission to an e-mail address.
- **>Email-address<**:
 - >From<: E-mail sender address (must be accepted by SMTP server)
 - >To<: E-mail destination address
- **>SMTP-Server<**: Specify e-mail server name (e.g. mail.gmx.net). Provider must support SMTP (Simple Mail Transfer Protocol).
- **>Port<**: Enter the port of the SMTP outgoing mail server.
- SSL encryption can be selected optionally.
- **>Username<**: E-mailbox user name.
- **>Password<**: Enter the password of the e-mailbox.
- **>Device to Web<**: Activate in case of transmission to D2W; a format compatible to Device to Web will be used.
- **>File format<**: Available formats are csv and txt.
- **>Data<**: Specify the data depth to transmit (Standard, Extended and Expert) (see chapter "39.3 Data Memory").
- **>Time<**: Specify the time of regular transmissions; the time specified serves as start time for the cyclic transmissions.
- **>Cycle time<**: Set the transmission cycle in hours (1, 2, 3, 4, 6, 8, 12 or 24h).
- **>Test settings<**: Use this menu to verify the settings, the results can be viewed in >Diag Output<.
- **>Start Data Transmission<**: Data (error information, archived data and current values) is transmitted, the result is issued on >Diag Output<.



Follow the procedure described in "Prepare the device for data transmission" on page 102.

42 Parameter Menu Display

Use the display menu to determine main screen attributes.

Variable settings:

- Names of the five main screen output fields
- Decimal places of individual values

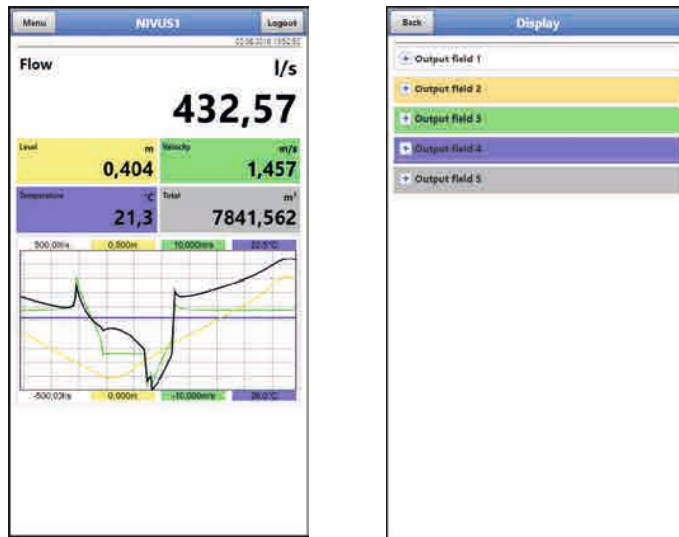

Fig. 42-1 Main screen and output fields

Output Fields

The five main screen output fields (Flow, Level, Velocity, Temperature and Total) can be specified freely in terms of name and the number of decimal places.



Assignment of values and output fields

The **assignment** of values and fields **cannot** be changed.

Example: the "Flow" field will **always** indicate output values even if the name should be changed to "Temperature".

➤ Procedure to **change the name**:

1. Drop down the desired output field.
2. Uncheck >Standard Name<.
3. Specify the new name. The name can be selected freely, however more than 16 characters will not be accepted.
The new name does **not** change the field value in the main screen.
4. Go "Back" several times to save the parameters

➡ To save parameters see chapter "35.1 Save Parameters".

➤ Procedure to **change the number of decimal places**:

1. Drop down the desired output field.
2. Uncheck >Default Digits<.
3. Specify the new number of digits.
Here you can enter any desired number, however more than a maximum of five digits will not be accepted.

4. Go "Back" several times to save the parameters.



Setting the number of digits

When setting the number of digits observe the measurement accuracy of the sensors and the measurement units set.

Example: the maximum resolution of the temperature sensor is 0.1 K.

43 Parameter Menu Battery (12V)

Use this menu to define the (rechargeable) battery type used as well as the according number of batteries.



Correct Indication of Battery Capacity

The capacity indication in the >System< / >Information< menu is reliable only as long as fully charged batteries are used and the battery type used as well as the according number of batteries are specified here.

Select from:

- **1x NFM0 ZAPB 1215 (E)**
One NIVUS rechargeable battery installed. The battery specifications are known and available from the software.
Setting the number of the NIVUS batteries used enables the correct indication of the battery performance in the >System< / >Information< menu.
- **2x NFM0 ZAPB 1215 (E)**
Two NIVUS rechargeable batteries installed.
- **BATTERIE_MODE_USER**
The capacity [Ah] must be specified to correctly indicate the (rechargeable) battery performance in the >System< / >Information< menu.

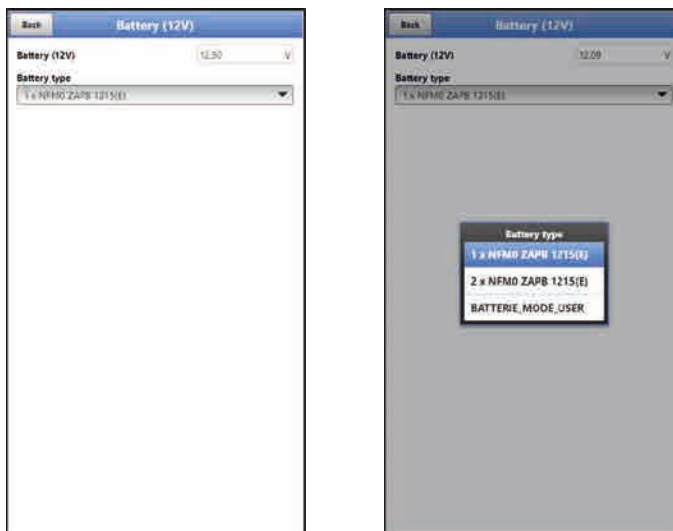

Fig. 43-1 Menu Battery (12V)

44 Parameter Menu Quick Start

The >Quick Start< parameter menu is subdivided into three or four pages (depending on the number of v-paths). The pages >Region Settings< and >Measure Place< are input pages used to define the indication of measurement values and the measurement place itself. Pages >v-Path 1< and >v-Path 2< are read-only pages and provide information on the sensor installation positions and the signal strength

➡ The parameter setting procedure is described in chapter “36 Parameter Setting using Quick Start”.

44.1 Menu >Quick Start< / >Region Settings<



Fig. 44-1 Region Settings

Use >Region Settings< to adjust the parameters below:

- (Operation) Language
- Date Format
- Units and Memory Units
- Change/synchronise system time and time zone
- Storage Mode
 - Operating Mode
 - Storage Cycle

The settings are explained in greater detail in chapters “40.2 Region Settings”, “40.3 Time/Date” and “40.6 Storage Mode”.

44.2 Menu >Quick Start< / >Measure Place<

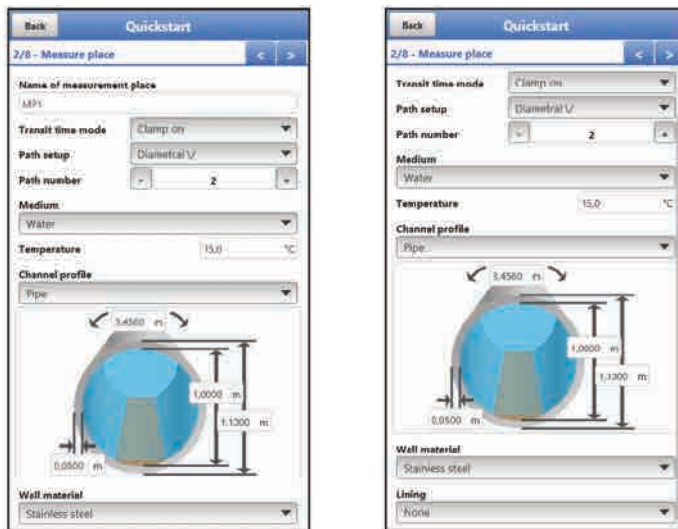

Fig. 44-2 Measurement Place

Use the >Measure Place< menu to adjust the parameters below:

- Name of Measurement Place
- Transit Time Mode
- Arrangement and Number of Paths
- Medium and Medium Temperature
- Channel Profile and Dimensions
- Wall Material and Lining

The individual settings are explained in greater detail in chapter “38.1 Menu Measure Place”.

44.3 Menu >Quick Start< / >v-Path 1<

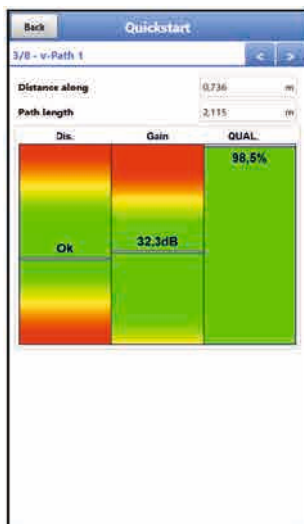

Fig. 44-3 v-Path 1

Under >v-Path 1< and >v-Path 2< the parameters below are indicated:

- Distance along
- Path length
- Signal strength

The values shown in >Distance along< and >Path length< can be used for sensor installation. The >Signal strength< is additional information: the higher the percentage the better the signal.

44.4 Menu >Quick Start< / >Analog Input 1<



Fig. 44-4 Analog input 1

Under >Analog input 1<, >Analog input 2< and >Analog input 3< the parameters below are set:

- External reading
- i-Sensor (HART)

The individual settings are explained in greater detail in chapter “38.3.1 Analog Inputs”.

44.5 Menu >Quick Start< / >Digital Input 1<



Fig. 44-5 Digital input 1

Under >Digital input 1< the parameters below are set:

- Runtime
- Impulse counter
- Logging

The individual settings are explained in greater detail in chapter “38.3.3 Digital Inputs”:

45 Parameter Menu Alert

The alert menu includes up to eight subsections: >Flow<, >Velocity<, >Water Temperature<, >Battery (12V)<, >Analog Input 1<, >Analog Input 2<, >Analog Input 3< and >Digital Input<. All subsections can be viewed only as soon as the analog and digital inputs have been previously assigned to a type under >Application< and hence have been activated (see chapters “38.3.1 Analog Inputs” and “38.3.3 Digital Inputs”).



Details on alarm management, alarm messages, alarm overview, status information etc. going beyond this instruction manual, can be found also in the NIVUS Web Portal handbook.

45.1 Menu >Alert< / >Flow<

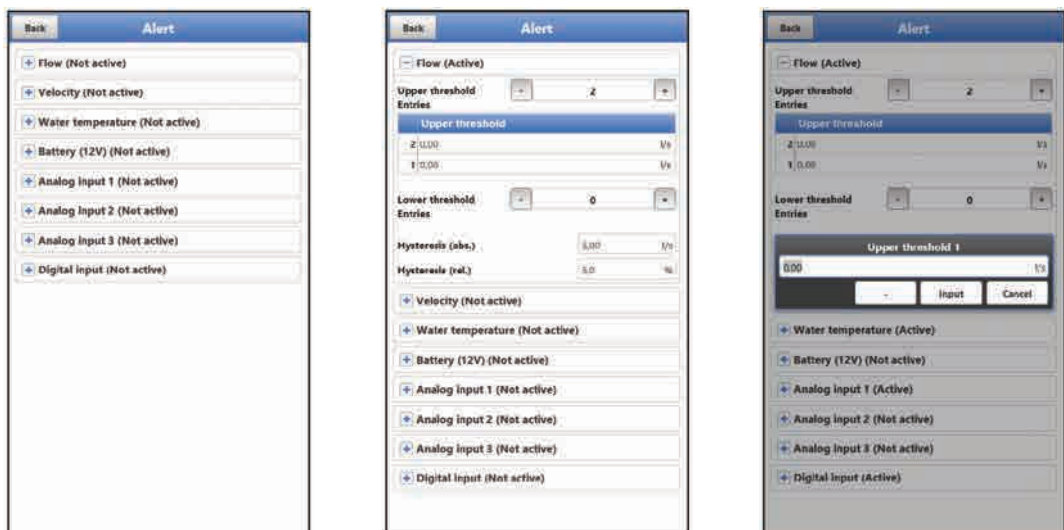

Fig. 45-1 Flow

The >Flow< subsection permits to specify up to five different limit values by using the “+” and “-” keys in >Upper threshold Entries< and in >Lower threshold Entries< each of which is used to trigger an alarm e-mail.

Define the threshold values by clicking the fields and by entering numerical values. The measurement transmitter will sort the specified threshold values in decreasing order. This is made independent from the input sequence.

In >Hysteresis (abs.)< and >Hysteresis (rel.)< values can be specified by clicking and typing. The measurement transmitter evaluates both values and sends an e-mail on reaching the highest top limit (highest possible value) and the lowest bottom value (lowest possible value). This mail includes the information that the alert is cancelled.

Default settings:

Hysteresis (abs.): values and units depend on the language settings previously adjusted

Hysteresis (rel.): 5.0 %



Alarm-E-Mail in case of defective flow velocity sensor

If you wish to receive an alert in case of a defective flow velocity sensor via e-mail check >Alert on error< under “45.3 Menu >Alert< / >Water temperature<”.

This setting is not adjusted in the “Flow” section here since the transmitter does not distinguish between “invalid” and “Error” during detection.

45.2 Menu >Alert< / >Velocity<

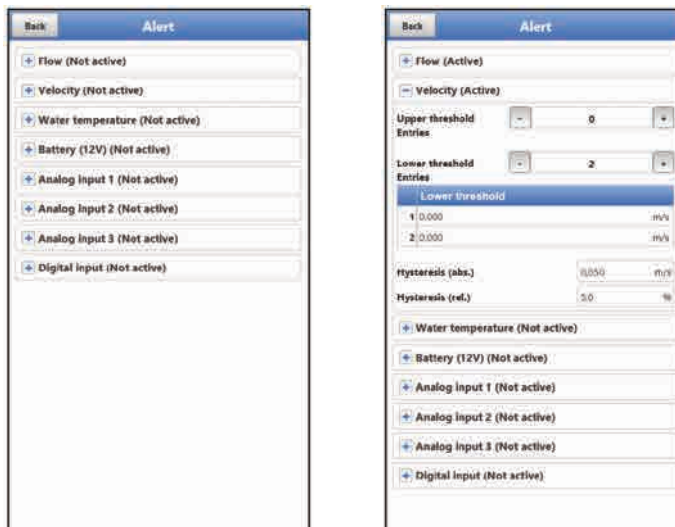

Fig. 45-2 Velocity

The >Velocity< subsection permits to specify up to five different limit values by using the “+” and “-” keys in >Upper threshold Entries< and in >Lower threshold Entries< each of which is used to trigger an alarm e-mail.

Define the threshold values by clicking the fields and by entering numerical values. The measurement transmitter will sort the specified threshold values in decreasing order. This is made independent from the input sequence.

In >Hysteresis (abs.)< and >Hysteresis (rel.)< values can be specified by clicking and typing. The measurement transmitter evaluates both values and sends an e-mail on reaching the highest top limit (highest possible value) and the lowest bottom value (lowest possible value). This mail includes the information that the alert is cancelled.

Default settings:

Hysteresis (abs.): values and units depend on the language settings previously adjusted

Hysteresis (rel.): 5.0 %

**Alarm-E-Mail in case of defective flow velocity sensor**

If you wish to receive an alert in case of a defective flow velocity sensor via email check >Alert on error< under “45.3 Menu >Alert< / >Water temperature<”.

This setting is not adjusted in the “Velocity” section here since the transmitter does not distinguish between “invalid” and “Error” during detection.

45.3 Menu >Alert< / >Water temperature<

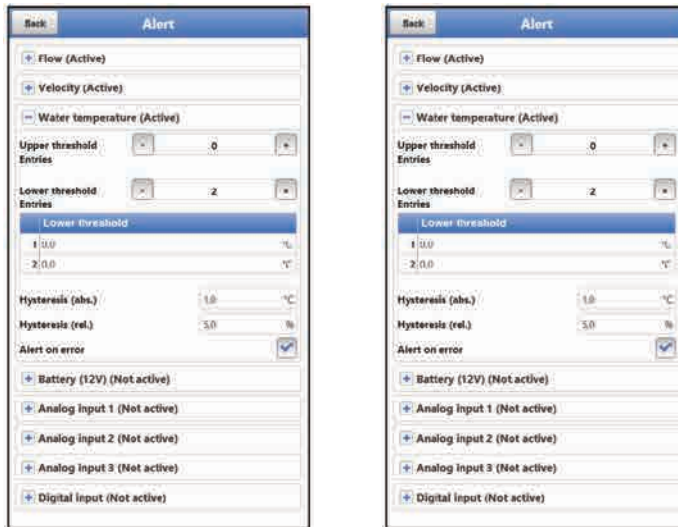

Fig. 45-3 Water temperature

The >Water temperature< subsection permits to specify up to five different limit values by using the “+” and “-” keys in >Upper threshold Entries< and in >Lower threshold Entries< each of which is used to trigger an alarm e-mail.

Define the threshold values by clicking the fields and by entering numerical values. The measurement transmitter will sort the specified threshold values in decreasing order. This is made independent from the input sequence.

In >Hysteresis (abs.)< and >Hysteresis (rel.)< values can be specified by clicking and typing. The measurement transmitter evaluates both values and sends an e-mail on reaching the highest top limit (highest possible value) and the lowest bottom value (lowest possible value). This mail includes the information that the alert is cancelled.

Default settings:

Hysteresis (abs.): values and units depend on the language settings previously adjusted

Hysteresis (rel.): 5.0 %

Moreover, the >Alert on error< option can be checked causing an active ongoing alert to send an alarm e-mail. Possible errors are cable breaks, interruptions, short circuits etc.

NIVUS recommend checking this option in order to receive an alert via e-mail once a flow velocity sensor should be defective or if the measurement pipe should have run empty. Both errors cause the flow measurement to fail.

45.4 Menu >Alert< / >Battery (12V)<

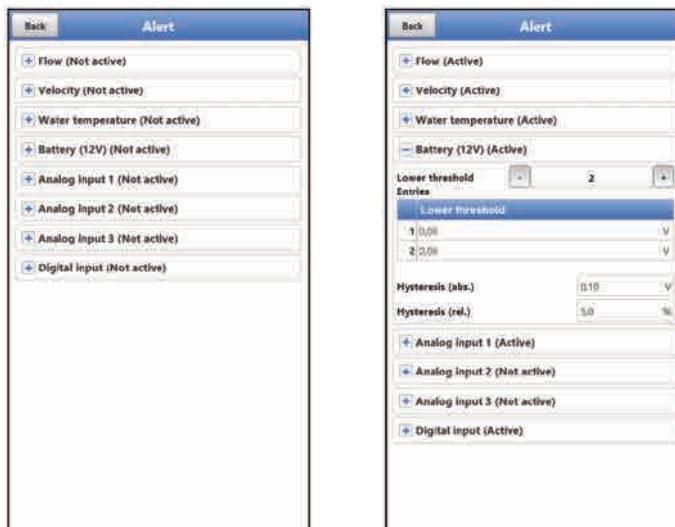

Fig. 45-4 Battery (12V)

The >Battery (12V)< subsection permits to specify up to five different limit values by using the “+” and “-” keys in >Lower threshold Entries< each of which is used to trigger an alarm e-mail.

Define the threshold values by clicking the fields and by entering numerical values. The measurement transmitter will sort the specified threshold values in decreasing order. This is made independent from the input sequence.

In >Hysteresis (abs.)< and >Hysteresis (rel.)< values can be specified by clicking and typing. The measurement transmitter evaluates both values and sends an e-mail on reaching the highest top limit (highest possible value) and the lowest bottom value (lowest possible value). This mail includes the information that the alert is cancelled.

Default settings:

Hysteresis (abs.): 0.10 V

Hysteresis (rel.): 5.0 %

45.5 Menu >Alert< / >Analog Input 1<

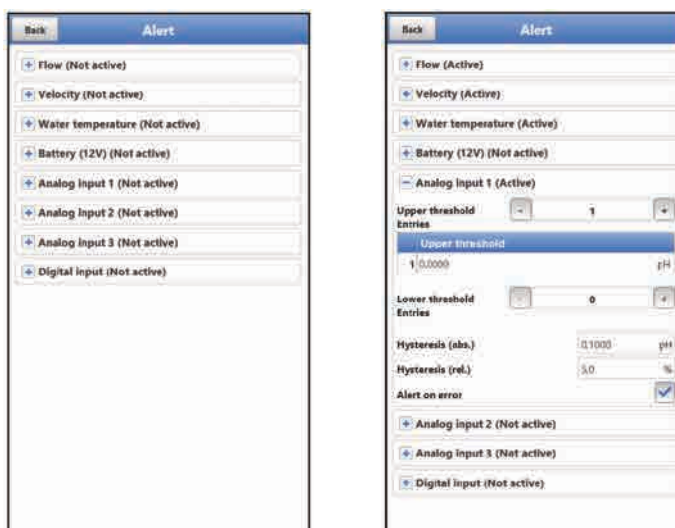

Fig. 45-5 Analog Input 1

The >Analog Input 1< subsection permits to specify up to five different limit values by using the “+” and “-” keys in >Upper threshold Entries< and in >Lower threshold Entries< each of which is used to trigger an alarm e-mail.

Define the threshold values by clicking the fields and by entering numerical values. The measurement transmitter will sort the specified threshold values in decreasing order. This is made independent from the input sequence.

In **>Hysteresis (abs.)<** and **>Hysteresis (rel.)<** values can be specified by clicking and typing. The measurement transmitter evaluates both values and sends an e-mail on reaching the highest top limit (highest possible value) and the lowest bottom value (lowest possible value). This mail includes the information that the alert is cancelled.

Default settings:

Hysteresis (abs.): value can be set, manual input while setting the analog input parameters

Hysteresis (rel.): 5.0 %

Moreover, the **>Alert on error<** option can be checked causing an active ongoing alert to send an alarm e-mail. Possible errors are cable breaks, interruptions, short circuits etc.

45.6 Menu >Alert< / >Analog Input 2<

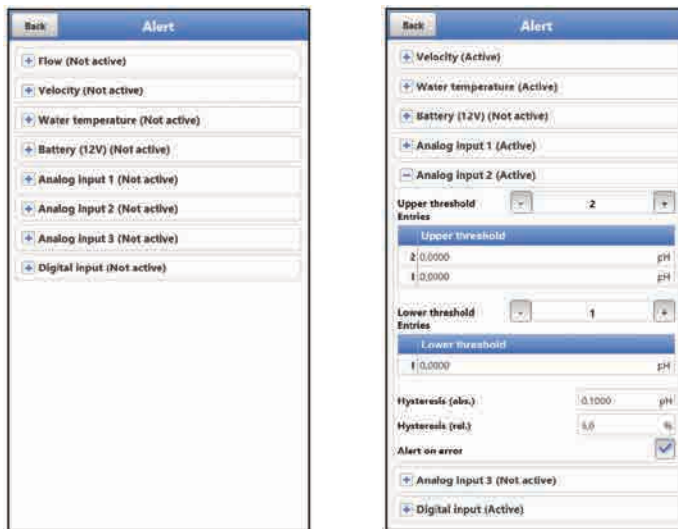

Fig. 45-6 Analog Input 2

The **>Analog Input 2<** subsection permits to specify up to five different limit values by using the “+” and “-” keys in **>Upper threshold Entries<** and in **>Lower threshold Entries<** each of which is used to trigger an alarm e-mail.

Define the threshold values by clicking the fields and by entering numerical values. The measurement transmitter will sort the specified threshold values in decreasing order. This is made independent from the input sequence.

In **>Hysteresis (abs.)<** and **>Hysteresis (rel.)<** values can be specified by clicking and typing. The measurement transmitter evaluates both values and sends an e-mail on reaching the highest top limit (highest possible value) and the lowest bottom value (lowest possible value). This mail includes the information that the alert is cancelled.

Default settings:

Hysteresis (abs.): any value can be set, manual input while setting the analog input parameters

Hysteresis (rel.): 5.0 %

Moreover, the **>Alert on error<** option can be checked causing an active ongoing alert to send an alarm e-mail. Possible errors are cable breaks, interruptions, short circuits etc.

45.7 Menu >Alert< / >Analog Input 3<

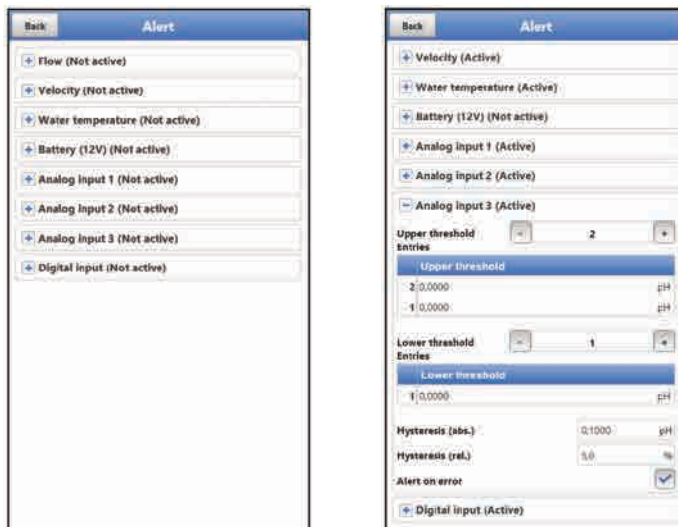

Fig. 45-7 Analog Input 3

The >Analog Input 3< subsection permits to specify up to five different limit values by using the “+” and “-” keys in >Upper threshold Entries< and in >Lower threshold Entries< each of which is used to trigger an alarm e-mail.

Define the threshold values by clicking the fields and by entering numerical values. The measurement transmitter will sort the specified threshold values in decreasing order. This is made independent from the input sequence.

In >Hysteresis (abs.)< and >Hysteresis (rel.)< values can be specified by clicking and typing. The measurement transmitter evaluates both values and sends an e-mail on reaching the highest top limit (highest possible value) and the lowest bottom value (lowest possible value). This mail includes the information that the alert is cancelled.

Default settings:

Hysteresis (abs.): value can be set, manual input while setting the analog input parameters

Hysteresis (rel.): 5.0 %

Moreover, the >Alert on error< option can be checked causing an active ongoing alert to send an alarm e-mail. Possible errors are cable breaks, interruptions, short circuits etc.

45.8 Menu >Alert< / >Digital Input<

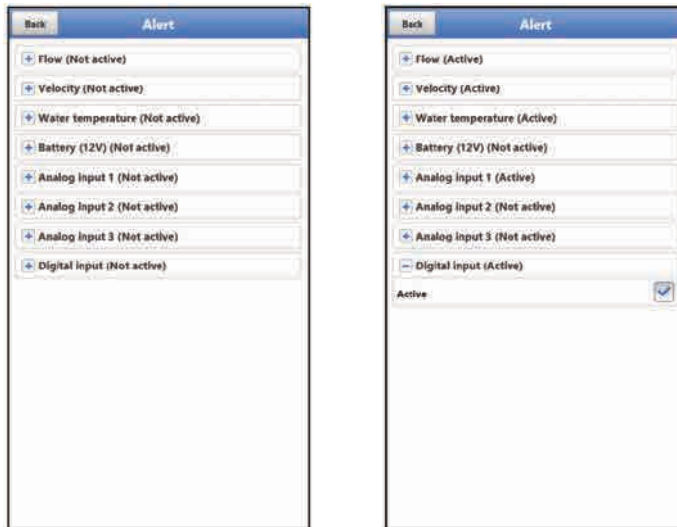

Fig. 45-8 Digital Input

Click the >Digital Input< checkbox in order to activate alarm e-mails in case of digital “Highs” on the digital input.

Default settings: unchecked

Diagnostics

46 Diagnostics Menu Principles

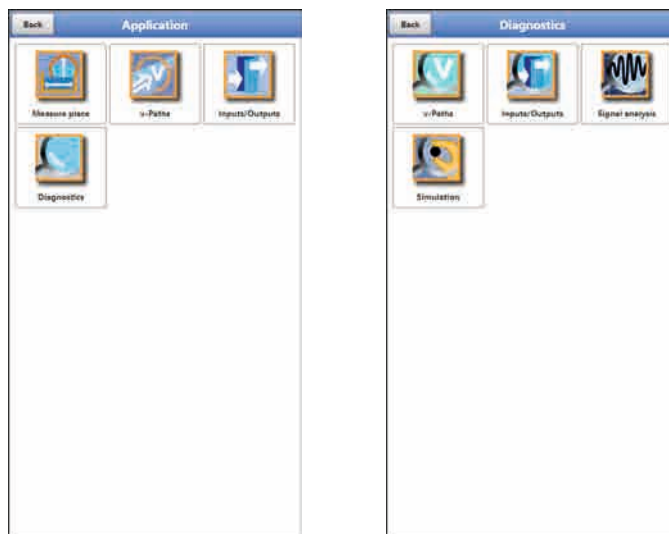

Fig. 46-1 Diagnostics Menu

The >Diagnostics< menu can be found in the >Application< menu and is split into four sub-menus.

This menu and all its submenus are read-only and simulation menus.

This section permits to view or to simulate settings on the areas below:

- v-Paths
- Inputs/Outputs
- Signal analysis
- Simulation



Observe the safety information on simulation

Necessarily observe the safety information on simulation on page 121.

47 Diagnostics Menu v-Paths



Fig. 47-1 Menu Diagnostics v-Paths / Alignment

This menu is required only for analytical purposes.

In case of errors or problems with the transit time measurement various factors can be used in order to determine the cause.

The following points are shown:

- **>v-Path<**
Indication of individual path velocities (switch by using the tabs top right).
- **>Delta t<**
Transit time difference in nanoseconds (to calculate the velocity v).
- **>Transit t<**
Mean signal runtime between sensor 1 and sensor 2 of the according path in microseconds.
- **>Transmission Power <**
- **>Angle<**
- **>Alignment<**
Tool for sensor positioning and thus for path alignment:
 - >Dist.<** (Distance):
Indicates via the arrow pointer whether the parameterized sensor position needs to be corrected because of the actual operating conditions (move together or further away from each other). In the green area the sensor position is optimal, in the yellow and red areas it needs to be adjusted.
 - >Gain<**:
Graphical representation of the receive gain. Gains in the green area are optimal. Care should be taken in the upper yellow area (high gain), as interference signals such as noise are also amplified there; this could cause the measurement system to fail. A measurement cannot be taken in the red area (very high gain): the measurement point is unsuitable for the measuring technique. Although a measurement can be taken in the lower yellow area (low gain), there is a risk of overcontrol, and thus of inaccurate measurement results.
 - >Qual.<** (Quality):
The quality display expresses as a percentage how well both sensors are installed relative to each other. This needs to be considered for clamp-on installations especially, since incorrectly mounted sensors can corrupt measurements.
- **>Temperature Compensation<** (calculated)
 - **>Path Temperature<**
Path temperature calculated from the speed of sound.

- **>Speed of Sound<**
Fixed value, depends on the medium.
- **>Offset (Transit Time)<**
Calculated value referring to the value specified in “Compensation Temperature”. To reset the value enter “0” manually.
- **>Compensation Temperature<**
Manual entry of the ACTUAL medium temperature measured. Required to calculate the offset (transit time).
- **>Zero Point Adjustment<**
 - **>Offset (Difference)<** and **>Adjustment<**
Detected velocity value available under “Delta t” in full filled channel with the discharge closed. Set to negative once selecting >Adjustment< and will be included with calculation accordingly.

48 Diagnostics Menu Inputs and Outputs

48.1 Important Information on the Simulation

DANGER



Personal injury and damage caused by improper simulation handling

The simulation will directly affect following plant sections. Disregarding may lead to personal injury or damage your facility.

The simulation shall be executed by trained electricians only who shall have sound knowledge on the entire control procedures of the according facility.

Prepare the simulation process carefully!

- *Switch the following systems to manual operation.*
- *Disable actuating drives and similar or limit the according functions.*

It is absolutely necessary to have a safety person available!

DANGER



Effects on plant sections

The simulation of NivuFlow Mobile outputs will directly affect any following plant sections without any safety locking measures.

Observe the hints contained within the above warning!



Important Note

NIVUS herewith in advance refuse any responsibility for any possible damage to persons or objects at any extent due to the extremely high risk of danger and unforeseeable consequences in the event of incorrect or faulty simulation!

This menu is divided in analog inputs, analog outputs, digital inputs and digital outputs.

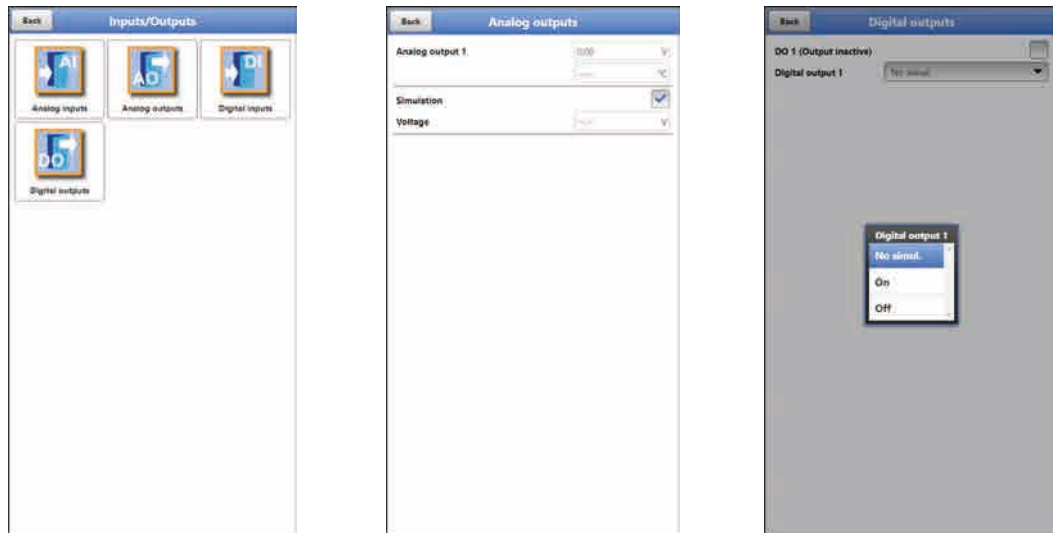

Fig. 48-1 Menu Inputs/Outputs

- **>Analog Inputs<**
Indicates the current values available at the according analog inputs.
- **>Analog Outputs<**
Indicates the available voltage values and the detected medium temperature.
By checking the **Simulation** box it is possible to simulate a voltage (Fig. 48-1).

Necessarily observe the previous safety information on the simulation and the possible risks (effects on following plant sections) on page 121!

- **>Digital Inputs<**
Signals oncoming at the digital inputs are indicated by a checked/unchecked box.
- **>Digital Outputs<**
Active digital outputs are checked.



Actual state of relay

The actual state of the real relay cannot be indicated, but only the signal transmitted to the relay.

This menu cannot be used to obtain information on external faulty wiring.

A **Simulation** of the digital output can be executed by either selecting **>No Simulation<**, **>On<** or **>Off<** (Fig. 48-1).

Necessarily observe the previous safety information on the simulation and the possible risks (effects on following plant sections) on page 121!

49 Diagnostics Menu Signal Analysis

This menu is used to scan and to review the incoming signal from the sensor. Moreover the sensor function can be tested here.

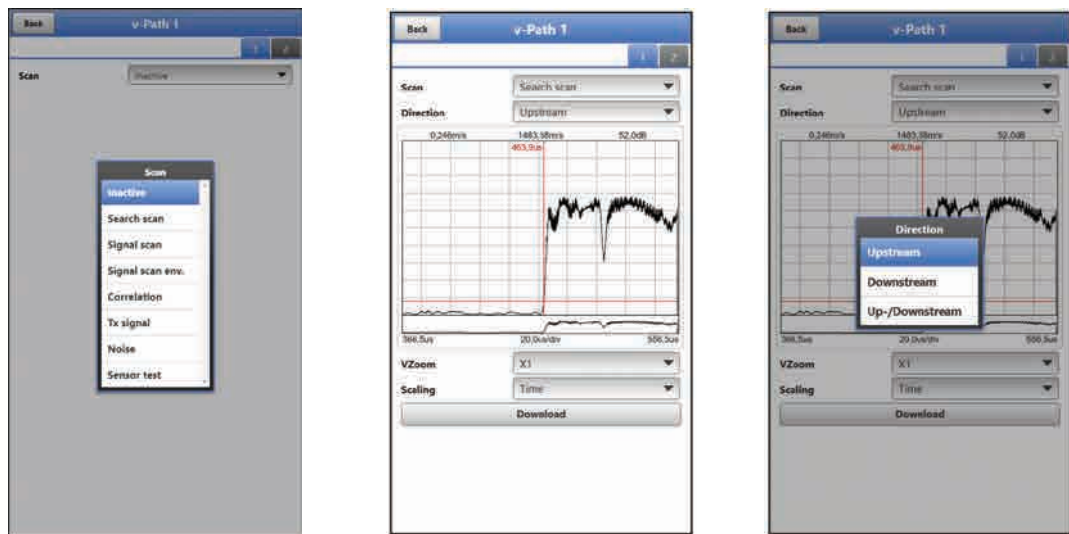

Fig. 49-1 Signal analysis menu / Search scan

Select from the options below:

- **>Inactive<**
No signal scan/evaluation
- **>Search Scan<** (Fig. 49-1)
(Coarse) signal scan based on customer settings and possibly extended ranges.
 - >Direction<**:
 - Upstream (towards flow direction)
 - Downstream (in flow direction)
 - Up-/Downstream
 - >VZoom<** of chart:
 - X1, X2, X5, X10, X20 and X50
 - >Scaling<** of chart:
 - Time
 - Distance
 - >Download<**
of current data or of screenshot (as .csv file) for analysis by NIVUS
- **>Signal Scan<** (Fig. 49-2)
More accurate signal indication.
 - >Direction<**:
 - Upstream (towards flow direction)
 - Downstream (in flow direction)
 - Up-/Downstream
 - >VZoom<** of chart:
 - X1, X2, X5, X10, X20 and X50

>Scaling< of chart:

- Time
- Distance

>Download<

of current data or of screenshot (as .csv file) for analysis by NIVUS

The >Scaling< is not available once the >FFT< (representation of the frequency spectrum) box is checked.

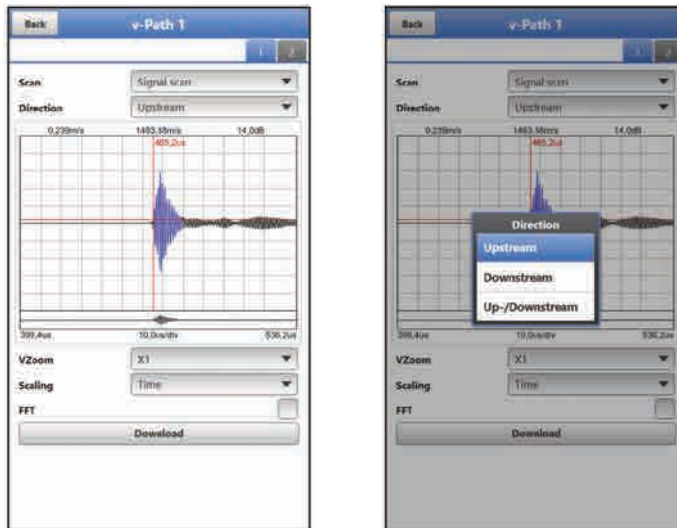

Fig. 49-2 Signal scan

- **>Signal Scan Envelope<** (Fig. 49-3)
Detection of the real start of the incoming signal (due to double reflection of the signal).

>Direction<:

- Upstream (towards flow direction)
- Downstream (in flow direction)
- Up-/Downstream

>VZoom< of chart:

- X1, X2, X5, X10, X20 and X50

>Scaling< of chart:

- Time
- Distance

>Download<

of current data or of screenshot (as .csv file) for analysis by NIVUS

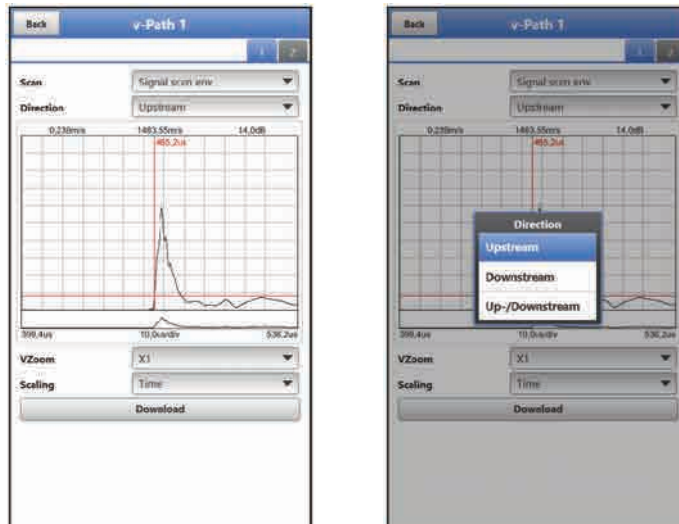

Fig. 49-3 Signal scan envelope

- **>Correlation<** (Fig. 49-4)
Visual comparison of both signals
>VZoom< of chart:
 - X1, X2, X5, X10, X20 and X50**>Download<**
of current data or of screenshot (as .csv file) for analysis by NIVUS

- **>Tx signal<** (Fig. 49-4)
Visual representation / signal shape
>VZoom< of chart:
 - X1, X2, X5, X10, X20 and X50**>Download<**
of current data or of screenshot (as .csv file) for analysis by NIVUS

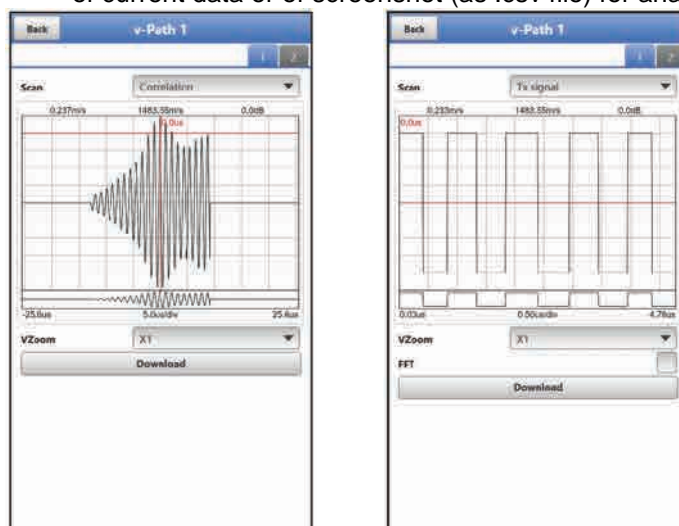

Fig. 49-4 Correlation / Tx signal

- **>Noise<** (Fig. 49-5)
Indication of unwanted background noise with signal evaluation
>Direction<:
 - Upstream (towards flow direction)

- Downstream (in flow direction)
- Up-/Downstream

>VZoom< of chart:

- X1, X2, X5, X10, X20 and X50

>Download<

of current data or of screenshot (as .csv file) for analysis by NIVUS

Check the >FFT< box to indicate the frequency spectrum.

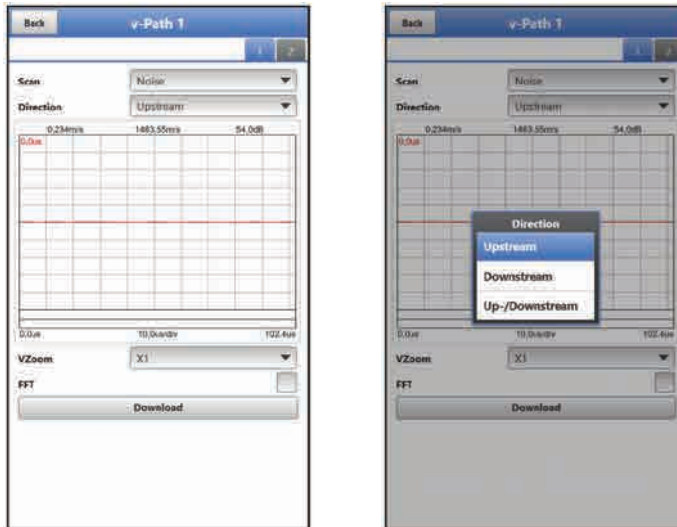

Fig. 49-5 Noise

- **>Sensor Test<** (Fig. 49-6)
Functional test of the connected sensor, detects obstacles such as air or sedimentation.

>Direction<:

- Upstream (towards flow direction)
- Downstream (in flow direction)
- Up-/Downstream

>VZoom< of chart:

- X1, X2, X5, X10, X20 and X50

>Scaling< of chart:

- Time
- Distance

>Download<

of current data or of screenshot (as .csv file) for analysis by NIVUS

Check the **>FFT<** box to indicate the frequency spectrum.

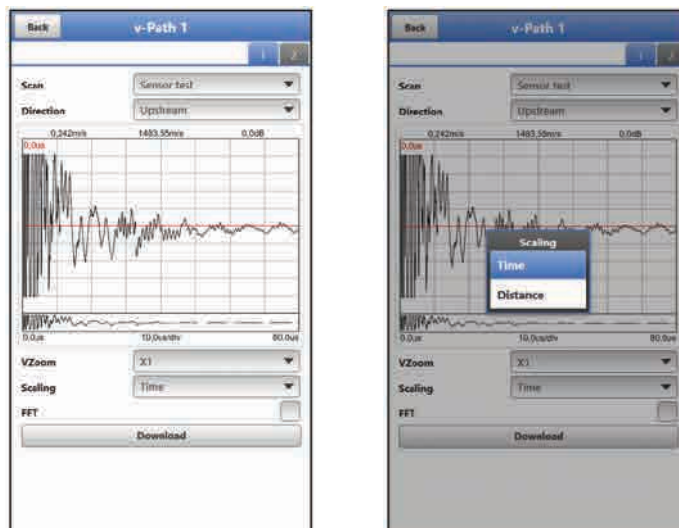

Fig. 49-6 Sensor Test

50 Simulation

DANGER



Effects on plant sections

The simulation of NivuFlow Mobile outputs will directly affect any following plant sections without any safety locking measures.

Observe the hints contained within the warning on page 121!

Stop the simulation with "Back".

This menu allows simulation of theoretical flow. Simulation is carried out by entering assumed level and velocity values. These values do **not** really exist.

Use either the >--<, >-<, >+< or >++< fields to enter smaller steps or specify absolute values (higher steps) directly in the >Velocity< field.

- = Decreases the velocity by 0.01 m/s per step
- = Decreases the velocity by 0.001 m/s per step
- + = Increases the velocity by 0.001 m/s per step
- ++ = Increases the velocity by 0.01 m/s per step

By using the simulated values (based on the channel dimension parameters set) NivuFlow Mobile calculates the prevailing flow.

Choosing >Flow< automatically indicates the calculated value.

>DO 1< shows the currently selected function.

The >Analog Output< option will output the voltage at the previously determined output.



Fig. 50-1 Simulation

Maintenance and Cleaning

WARNING



Disconnect instrument from mains power

Disconnect the instrument from mains power and safeguard the higher system against restart before you begin maintenance works.

Disregarding may lead to electric shocks.

WARNING



Check danger due to explosive gases

Make sure to observe all regulations regarding safety at work as well as danger due to explosive gases prior to beginning mounting, installation and maintenance works. Use a gas warner.

When working in channel systems make sure to avoid electrostatic charge:

- *Avoid unnecessary movements to minimise the risk of static energy accumulating.*
- *Discharge any possible static electricity from your body before you begin to install the sensor.*

Disregarding may lead to personal injury or damage your facility.

WARNING



Germ contamination possible

Due to being frequently used in wastewater applications, some portions of the measurement system may be loaded with hazardous germs. This is why precautionary measures shall be taken while being in contact with cables and sensors.

Wear protective clothing.

51 Maintenance

51.1 Maintenance Interval

The Type NivuFlow Mobile transmitters are conceived to be virtually free of calibration, maintenance and wear.

NIVUS, however, recommend having the entire measurement system inspected by the NIVUS customer service **once per year**.

Depending on the area of use the maintenance intervals may vary. Extent and intervals of maintenance depend on the following conditions:

- Measurement principle of sensors
- Material wear
- Measurement medium and hydraulic conditions
- General regulations for the operators of the measurement facility
- Ambient conditions

In addition to the annual inspection NIVUS recommends a complete maintenance of the measurement system by NIVUS GmbH after **ten years the latest**.

In general, the inspection of instruments/sensors is a basic measure which helps to increase operational safety as well as the lifetime.

51.2 Customer Service Information

For annual inspection of the entire measurement system or complete maintenance after ten years the latest contact our customer service:

NIVUS GmbH - Customer Service

Phone +49 (0) 7262 9191 - 922

Customercenter@nivus.com

52 Cleaning

52.1 Transmitter

WARNING



Disconnect instrument from mains power

Observe to disconnect the transmitter from mains power.

Disregarding may induce the risk of electrical shocks.

DANGER



Danger due to electrostatic discharge

Clean the device only with a damp cloth.

Disregarding invalidates the device's explosion protection due to possible static charge.

In such a case the unit poses a threat to the user's life and may cause an ignition in an explosive atmosphere.

When closed and locked the NivuFlow Mobile enclosure complies with IP68 protection degree and hence is less sensitive. Do **not** use high-pressure cleaners however.

Do **not** use sharp cleansing agents or solvents. Light household cleaners or soapy water can be used instead.

52.2 Power Adapter/Battery Charger

Clean power adapter/battery charger and charging tray only with a **slightly damp** cloth. The components are not protected against the ingress of moisture.

52.3 Sensors

Information on how to maintain and to clean the sensors shall be necessarily observed. Such information can be found in the according technical description or instruction manual.

Technical descriptions or instruction manuals are part of the sensor delivery.

53 Dismantling/Disposal

Improper disposal may be harmful to the environment.

➡ Always dispose equipment components and packaging materials according to applicable local regulations on environmental standards for electronic products:

1. Disconnect the instrument from mains power.
2. Remove connected cables.
3. Remove batteries and if defect dispose accordingly.
4. Remove the transmitter's buffer battery and separately dispose accordingly.



EC WEEE-Directive

This symbol indicates that the Directive 2012/19/EU on waste electrical and electronic equipment requirements shall be observed on the disposal of the equipment. NIVUS GmbH supports and promotes the recycling and environmentally friendly, separate collection/disposal of waste electrical and electronic equipment in order to protect the environment and human health. Observe the local disposal regulations and laws.

NIVUS GmbH is registered with the EAR, therefore public collection and return points in Germany can be used for disposal.

The unit contains a buffer battery (Lithium coin cell), which must be disposed of separately.

54 Installation of spare parts and parts subject to wear and tear

We herewith particularly emphasise that replacement parts or accessories not supplied by NIVUS moreover are not certified and approved by NIVUS too. Installation and/or the use of such products hence may negatively influence predetermined constructional characteristics of the measurement system or even lead to instrument failures.

NIVUS cannot be held responsible for any damage resulting due to the use of non-original parts and non-original accessories.

55 Accessories

NFM0 ZAPB 1215	Rechargeable battery pack with sockets; nominal voltage: 12 V; capacity: 15 Ah
NFM0 ZAPB 1215 E	Rechargeable battery pack with sockets for NFM with ATEX approval zone 1; nominal voltage: 12 V; capacity: 15 Ah
NFM0 ZLAD	Power adapter/battery charger for NFM / NFM battery pack; supply voltage: 100...240 V AC, 50/60 Hz
NFM0 ZVER PS	2-wire connection cable for external power supply connection to NFM (one side with plug for multifunction socket, other side with open cable ends); cable length 5 m
NFM0 ZAB 01	Display and operation module for NFM: IP67-certified 8" outdoor tablet; resolution: 1280x800; operating system: Android; device communication: WLAN; other communication modes: USB, Bluetooth, modem 2G, 3G and 4G
NFM0 ZVER AA	Connection cable, NFM analog output (one side with plug for multifunction socket, other side with open cable ends); cable length 10 m
NFM0 ZVER AEA	Connection cable, NFM analog input; supplied by NFM (one side with plug for multifunction socket, other side with open cable ends); cable length 10 m

<i>NFM0 ZVER AEP</i>	Connection cable, NFM analog input; external power supply (one side with plug for multifunction socket, other side with open cable ends); cable length 10 m
<i>NFM0 ZVER DE</i>	Connection cable, NFM digital input (one side with plug for multifunction socket, other side with open cable ends); cable length 10 m
<i>NFM0 ZVER DA</i>	Connection cable, NFM relay output (one side with plug for multifunction socket, other side with open cable ends); cable length 10 m
<i>NFM0 ZVER NLM</i>	Connection cable between NFM and NivuLog Easy (one side with plug for multifunction socket, other side with open cable ends); cable length 5 m
<i>NFM0 ZVS1</i>	Connector Box, IP67 with NFM connection plug for connection to NFM
<i>ZUB0 KAB NMC 10</i>	2-pole, preconfigured cable with open cable ends for connection to Connector Box; cable length 10 m
<i>ZUB0 KAB NMC 20</i>	2-pole, preconfigured cable with open cable ends for connection to Connector Box; cable length 20 m
<i>ZUB0 KAB NMC 30</i>	2-pole, preconfigured cable with open cable ends for connection to Connector Box; cable length 30 m
<i>NFM0 ZSBL IRE</i>	Hoop guards (pair), for protection of connection sockets and to fasten the Connector Box on the NFM
<i>NFM0 ZHAK NFM 01</i>	Suspension bracket to fasten the NFM on step irons incl. brackets for suspension of sensor cables; material: stainless steel 1.4571
<i>NFM0 ZHAK NFM 02</i>	Suspension bracket to fasten the NFM on step irons; material: stainless steel 1.4571
<i>NFM5 GUMMI PUFFER</i>	Rubber buffers, set of 4 pcs.
<i>NFM0 Z ANT1</i>	NFM GPRS T-Shape antenna Ex-It GSM/3G, cable length 2.5 m, for connection to NFM with GPRS data remote transmission
<i>ZUB0 NFM SCHLOSS</i>	Padlock for Ex-version transmitter (to secure the device when used in Ex areas)
<i>BSL0 EP 220-20</i>	EnerPro 220 Tr / 20kA, overvoltage protection for power lines
<i>BSL0 EP 220-5</i>	EnerPro 220 Tr / 5kA, overvoltage protection for power lines
<i>BSL0 DP 2X12/12</i>	DataPro 2x1-12V/12V-11µH-Tr(N), 20,000 A leakage current, 2-wired for sensor lines

You can find more accessories and spare parts in the valid NIVUS price list.

Index

- A**
- Accessories..... 131
 - Accident level..... 14
 - Airfreight..... 20, 21
 - Alert..... 72, 112
 - Alignment..... 120
 - Distance..... 120
 - Gain..... 120
 - Quality..... 120
 - Android operating system..... 46
 - Antenna..... 44
 - Approvals..... 25, 137
 - Article no..... 23, 26, 69, 91
 - Automatic data transmission..... 64
- B**
- Basic menus..... 57
 - Battery charger..... 12, 33, 34, 35, 36, 43, 131
 - Cleaning..... 130
 - Battery charging status..... 91
 - Battery life..... 34
 - Battery type..... 32, 108
 - Branches..... 2
 - Buffer battery..... 16, 94
- C**
- Cable
 - Sensor connection..... 39
 - Calming section..... 37
 - Capacity..... 34
 - Battery..... 108
 - Capacity indication
 - Battery..... 71
 - Certificates..... 137
 - Channel dimensions..... 76
 - Channel profiles..... 75
 - Charge capacity
 - Battery..... 34
 - Charging tray..... 33, 34
 - Cleaning..... 16, 19, 130
 - Codes..... 136
 - Colour code
 - Wires..... 11
 - Compensation temperature..... 121
 - Compress..... 90
 - Connectable sensors..... 23
 - Connection sockets..... 31
 - Connections..... 11, 19, 21
 - Connector box..... 21, 42
 - Continuous event mode..... 100
 - Continuous operation..... 100
 - Coordinated universal time UTC..... 94
 - Copyright..... 3
 - Correlation
 - Simulation..... 125
 - Credits..... 136
 - Current measurement data..... 86
 - Customer centre..... 104
 - Customer Service..... 130
 - Cycle mode..... 100
- D**
- Damping..... 77, 78
 - Data remote transfer..... 26
 - Data transmission..... 25, 44
 - Automatic..... 64
 - Date..... 94
 - Delete storage..... 90
 - Delivery..... 20
 - Delta t..... 120
 - Device identification..... 23
 - Device types..... 26
 - Diagnostics..... 85, 119
 - Inputs/Outputs..... 121
 - Principles..... 119
 - Signal analysis..... 123
 - v-Paths..... 120
 - Dismantling..... 131
 - Display overview..... 55
 - Disposal..... 131
 - Battery..... 35
 - Disposal of materials..... 19
 - Disposal of products..... 19
 - Download..... 10, 90
- E**
- EC WEEE-Directive..... 131
 - Enclosure..... 25
 - Enclosure dimensions..... 23
 - Erase error memory..... 95
 - Error messages..... 57, 69, 95
 - Event interval..... 100
 - Event mode..... 100
 - Ex approvals..... 25
 - Explosive gases..... 15, 30, 129
- F**
- Firmware version..... 91
- G**
- Gaskets
 - Enclosure cover..... 30
 - Germs..... 16

GPRS.....	103
Antenna	44
DNS	104
E-Mail.....	106
FTP.....	105
Modem state	103
MQTT.....	104
SIM-Card	103

H

Hoop guards	21
Hotline.....	45
Humidity.....	25
Hydraulic factor.....	79

I

Indication of Capacity	
Battery	108
Inner lining material	
Pipe.....	58
Inner linings	
Pipe.....	77
Inputs/Outputs	
Connector box	42
Inputs/Outputs	
Single external connection	41
Installation.....	30
Clamp-On Sensors	37
in places tending to overflow	31
Wet sensors.....	38
Installation place	30
Instructions.....	45
Interface	13
Communication.....	57
Mobile communications	44
USB	11, 18, 22, 64, 89

iOS

Operating system.....	49
-----------------------	----

L

Liability disclaimer.....	17
Licenses.....	136
Load parameters.....	90
Low-flow suppression	77

M

Maintenance interval.....	129
Measurement medium	73
Measurement place	37
Measurement principle	25
Medium	75, 76, 77
Medium temperature.....	55, 73, 75

Mounting place.....	79
Mounting position	
Sensors.....	79

N

Nameplate.....	18, 23
Names.....	3
National language	92
NIVUS addresses	2
Noise	
Simulation	125

O

Operating elements.....	12
Operating mode	65, 100, 109
Operating ranges	27
Operating system	
Android.....	46
iOS	49
Windows	52
Operating temperature.....	25

P

Parameter reset	96
Parts subject to wear and tear	131
Path arrangement	
Clamp-on mode	74
Wet mode.....	74
Path arrangements	37
Diametrical \.....	37
Diametrical V	37
Diametrical VV	37
Pipe material	28
Power adapter.....	33, 34, 36, 43, 131
Cleaning.....	130
Power failure	94
Power supply	25
Powerdown	96
Precautions	15
Product construction	22
Product overview	22
Property rights.....	3
Protection degree.....	31, 130
Protective conductor	15
PUK.....	47, 50, 53, 63, 104

Q

Q suppressed.....	77
Qualified expert personnel.....	10, 16, 19, 31, 45
Questions concerning licenses	136
Quick Start	57, 65, 71, 109

- R**
- Reception inspection 20
 - Rechargeable battery type..... 108
 - Region settings 71, 91, 109
 - Repeatedly measure the same measurement places..... 62
 - Restart 96
 - Return 21
 - Rubber buffers 21, 42, 132
- S**
- Safeguards..... 15
 - Safety information
 - Simulation 119, 122
 - Safety Instructions 14
 - Save data to USB 90
 - Save parameters 90
 - Search scan
 - Simulation 123
 - Sedimentation 77
 - Sensor test
 - Simulation 127
 - Sensor type..... 37
 - Serial no..... 23, 36, 47, 50, 53, 63, 69
 - Series no..... 23
 - Service level..... 95, 96
 - Setting up connection
 - Android operating system..... 46
 - iOS operating system 49
 - Windows operating system..... 52
 - Signal analysis
 - Simulation 123
 - Signal scan
 - Simulation 123
 - Signal strength 103, 110
 - Signal words
 - used 14
 - Simulation
 - Important information..... 121
 - Sludge level 77
 - Socket for battery
 - Charging 32, 35, 36
 - Discharging..... 32, 35, 36
 - Spare parts 131, 132
 - Specifications..... 25
 - SSID..... 63
 - Stability 78
 - Start-Up examples
 - Clamp-On sensors..... 58
 - Wet sensors..... 61
 - Stickers 20, 21, 30
 - Storage 21
 - Storage cycle 25, 100
 - Storage temperature 25
 - Super-PIN 63
 - Symbols
 - used 14
 - System time 94
- T**
- Temperature compensation 120
 - Time switch 94
 - Totalising process 87
 - Transit t 120
 - Transit time difference
 - Determination 28
 - Measurement method 27, 28, 36
 - Principle 27
 - Translation 3
 - Transport..... 21
 - T-Shape antenna 44
 - Tx signal
 - Simulation 125
- U**
- USB Stick..... 64, 89
 - Use in accordance with the requirements 17
 - User's responsibilities 19
 - UTC Coordinated universal time..... 94
- V**
- v suppressed..... 77
 - v-Maximum
 - Mounting position..... 80
 - v-Minimum
 - Mounting position..... 80
- W**
- Waking up
 - Android..... 46
 - iOS 49
 - Windows 53
 - Wall material 76
 - Warning notices on the product 15
 - Warranty 16
 - Weighting 79
 - Windows
 - Operating system..... 52
 - Wires
 - Colour code..... 11
 - WLAN..... 102
 - WLAN password 62
- Z**
- Zero point adjustment 121

Credits and Licenses

56 List of references of the licenses and codes used

The transmitter type NivuFlow uses code of the following Open Source Projects:

- Freetype (<http://www.freetype.org>)
- Libharu (<http://libharu.org>)
- Libjpeg (<http://www.ijg.org>)
- Libpng (<http://www.libpng.org>)
- Zlib (<http://www.zlib.net>)
- Mini-XML (<http://www.msweet.org>)
- Nano-X/nxlib (<http://www.microwindows.org>)
- FLTK (<http://www.fltk.org>)
- Appendix1: LGPL
- Appendix2: MPL



Questions concerning licenses

If you have any questions concerning licenses refer to opensource@nivus.com

Approvals and Certificates

DE / EN / FR



NIVUS GmbH
Im Täle 2
75031 Eppingen

Telefon: +49 07262 9191-0
Telefax: +49 07262 9191-999
E-Mail: info@nivus.com
Internet: www.nivus.de

EU Konformitätserklärung

EU Declaration of Conformity

Déclaration de conformité UE

Für das folgend bezeichnete Erzeugnis:

For the following product:

Le produit désigné ci-dessous:

Bezeichnung:	Portabler Durchflussmessumformer/-datenlogger, Standardausführung NivuFlow Mobile / NivuLevel Mobile
<i>Description:</i>	<i>Portable flow measurement transmitter/data logger, standard version NivuFlow Mobile / NivuLevel Mobile</i>
<i>Désignation:</i>	<i>Débitmètre/enregistreur de données portable, version standard NivuFlow Mobile / NivuLevel Mobile</i>
Typ / Type:	NFM0xxx00 00

erklären wir in alleiniger Verantwortung, dass die auf dem Unionsmarkt ab dem Zeitpunkt der Unterzeichnung bereitgestellten Geräte die folgenden einschlägigen Harmonisierungsvorschriften der Union erfüllen:

we declare under our sole responsibility that the equipment made available on the Union market as of the date of signature of this document meets the standards of the following applicable Union harmonisation legislation:

nous déclarons, sous notre seule responsabilité, à la date de la présente signature, la conformité du produit pour le marché de l'Union, aux directives d'harmonisation de la législation au sein de l'Union:

- 2014/53/EU
- 2011/65/EU

Bei der Bewertung wurden folgende einschlägige harmonisierte Normen zugrunde gelegt bzw. wird die Konformität erklärt in Bezug auf die nachfolgend genannten anderen technischen Spezifikationen:

The evaluation assessed the following applicable harmonised standards or the conformity is declared in relation to other technical specifications listed below:

L'évaluation est effectuée à partir des normes harmonisées applicables ou la conformité est déclarée en relation aux autres spécifications techniques désignées ci-dessous:

- EN 61010-1:2010
- EN 62311:2008
- EN 61326-1:2013
- ETSI EN 301 489-1 V2.1.1
- ETSI EN 301 489-17 V3.1.1
- EN 300 328 V2.2.2 (WLAN)
- EN 301 893 V2.1.1 (WLAN)
- EN 300 440 V2.1.1 (WLAN)

Diese Erklärung wird verantwortlich für den Hersteller:

This declaration is submitted on behalf of the manufacturer:

Le fabricant assume la responsabilité de cette déclaration:

NIVUS GmbH
Im Täle 2
75031 Eppingen
Allemagne

abgegeben durch / *represented by / faite par:*

Marcus Fischer (Geschäftsführer / *Managing Director / Directeur général*)

Eppingen, den 21.07.2021

Gez. *Marcus Fischer*

DE / EN / FR

EU Konformitätserklärung

EU Declaration of Conformity

Déclaration de conformité UE



NIVUS GmbH
Im Täle 2
75031 Eppingen

Telefon: +49 07262 9191-0
Telefax: +49 07262 9191-999
E-Mail: info@nivus.com
Internet: www.nivus.de

Für das folgend bezeichnete Erzeugnis:

For the following product:

Le produit désigné ci-dessous:

Bezeichnung:	"Ex" Portabler Durchflussmessumformer/-datenlogger, Standardausführung NivuFlow Mobile / NivuLevel Mobile
<i>Description:</i>	<i>"Ex" Portable flow measurement transmitter/data logger, standard version NivuFlow Mobile / NivuLevel Mobile</i>
<i>Désignation:</i>	<i>"Ex" Débitmètre/enregistreur de données portable, version standard NivuFlow Mobile / NivuLevel Mobile</i>
Typ / Type:	NFM0xxx0E 00

erklären wir in alleiniger Verantwortung, dass die auf dem Unionsmarkt ab dem Zeitpunkt der Unterzeichnung bereitgestellten Geräte die folgenden einschlägigen Harmonisierungsvorschriften der Union erfüllen:

we declare under our sole responsibility that the equipment made available on the Union market as of the date of signature of this document meets the standards of the following applicable Union harmonisation legislation:

nous déclarons, sous notre seule responsabilité, à la date de la présente signature, la conformité du produit pour le marché de l'Union, aux directives d'harmonisation de la législation au sein de l'Union:

- 2014/53/EU
- 2014/34/EU
- 2011/65/EU

Bei der Bewertung wurden folgende einschlägige harmonisierte Normen zugrunde gelegt bzw. wird die Konformität erklärt in Bezug auf die nachfolgend genannten anderen technischen Spezifikationen:

The evaluation assessed the following applicable harmonised standards or the conformity is declared in relation to other technical specifications listed below:

L'évaluation est effectuée à partir des normes harmonisées applicable ou la conformité est déclarée en relation aux autres spécifications techniques désignées ci-dessous:

- EN 61010-1:2010
- Draft ETSI EN 301 489-1 V2.2.0
- EN 300 328 V2.2.2 (WLAN)
- EN IEC 60079-0:2018
- EN 60079-18:2015/A1:2017
- EN 62311:2008
- Draft ETSI EN 301 489-17 V3.2.0
- EN 301 893 V2.1.1 (WLAN)
- EN IEC 60079-7:2015/A1:2018
- EN 61326-1:2013
- EN 300 440 V2.1.1 (WLAN)
- EN 60079-11:2012

Ex-Kennzeichnung / *Ex-designation* / *Marquage Ex* :

⊕ II 2G Ex eb ib [ib] mb IIB T4 Gb

EU-Baumusterprüfbescheinigung / *EU-Type Examination Certificate* / *Attestation d'examen «UE» de type:*

TÜV 17 ATEX 196722 X issue: 01

Notifizierte Stelle (Kennnummer) / *Notified Body (Identif. No.)* / *Organisme notifié (N° d'identification)*

TÜV NORD CERT GmbH, Langemarckstraße 20, 45141 Essen, Germany

(0044)

Diese Erklärung wird verantwortlich für den Hersteller:

This declaration is submitted on behalf of the manufacturer:

Le fabricant assume la responsabilité de cette déclaration:

NIVUS GmbH
Im Täle 2
75031 Eppingen
Allemagne

abgegeben durch / *represented by* / *faite par:*

Marcus Fischer (Geschäftsführer / *Managing Director* / *Directeur général*)

Eppingen, den 06.07.2021

Gez. *Marcus Fischer*

DE / EN / FR

EU Konformitätserklärung

EU Declaration of Conformity

Déclaration de conformité UE



NIVUS GmbH
Im Täle 2
75031 Eppingen

Telefon: +49 07262 9191-0
Telefax: +49 07262 9191-999
E-Mail: info@nivus.com
Internet: www.nivus.de

Für das folgend bezeichnete Erzeugnis:

For the following product:

Le produit désigné ci-dessous:

Bezeichnung:	Portabler Durchflussmessumformer/-datenlogger mit internem Modem zur Datenfernübertragung über GPRS/UMTS/LTE NivuFlow Mobile/NivuLevel Mobile
<i>Description:</i>	<i>Portable flow measurement transmitter/data logger with internal modem for data transmission via GPRS/UMTS/LTE NivuFlow Mobile/NivuLevel Mobile</i>
<i>Désignation:</i>	<i>Débitmètre/enregistreur de données portable avec modem interne pour la transmission de données à distance via GPRS/UMTS/LTE NivuFlow Mobile/NivuLevel Mobile</i>
Typ / Type:	NFM0xxxG0 Ex

erklären wir in alleiniger Verantwortung, dass die auf dem Unionsmarkt ab dem Zeitpunkt der Unterzeichnung bereitgestellten Geräte die folgenden einschlägigen Harmonisierungsvorschriften der Union erfüllen:

we declare under our sole responsibility that the equipment made available on the Union market as of the date of signature of this document meets the standards of the following applicable Union harmonisation legislation:

nous déclarons, sous notre seule responsabilité, à la date de la présente signature, la conformité du produit pour le marché de l'Union, aux directives d'harmonisation de la législation au sein de l'Union:

- 2014/53/EU
- 2011/65/EU

Bei der Bewertung wurden folgende einschlägige harmonisierte Normen zugrunde gelegt bzw. wird die Konformität erklärt in Bezug auf die nachfolgend genannten anderen technischen Spezifikationen:

The evaluation assessed the following applicable harmonised standards or the conformity is declared in relation to other technical specifications listed below:

L'évaluation est effectuée à partir des normes harmonisées applicable ou la conformité est déclarée en relation aux autres spécifications techniques désignées ci-dessous:

- EN 61010-1:2010
- EN 61326-1:2013
- Draft ETSI EN 301 489-17 V3.1.1
- Draft ETSI EN 301 489-52 V1.1.0
- EN 301 893 V2.1.1 (WLAN)
- EN 301 511 V12.5.1 (GSM/2G)
- EN 301 908-2 V13.1.1 (UMTS/3G)
- EN 62311:2008
- EN 301 489-1 V2.2.3
- Draft ETSI EN 301 489-19 V2.1.1
- EN 300 328 V2.2.2 (WLAN)
- EN 300 440 V2.1.1 (WLAN)
- EN 301 908-1 V13.1.1 (UMTS/3G, LTE/4G)
- EN 301 908-13 V13.1.1 (LTE/4G)

Diese Erklärung wird verantwortlich für den Hersteller:

This declaration is submitted on behalf of the manufacturer:

Le fabricant assume la responsabilité de cette déclaration:

NIVUS GmbH
Im Täle 2
75031 Eppingen
Allemagne

abgegeben durch / *represented by / faite par:*

Marcus Fischer (Geschäftsführer / *Managing Director / Directeur général*)

Eppingen, den 06.07.2021

Gez. *Marcus Fischer*

DE / EN / FR

EU Konformitätserklärung

EU Declaration of Conformity

Déclaration de conformité UE

Für das folgend bezeichnete Erzeugnis:

For the following product:

Le produit désigné ci-dessous:



NIVUS GmbH
Im Täle 2
75031 Eppingen

Telefon: +49 07262 9191-0
Telefax: +49 07262 9191-999
E-Mail: info@nivus.com
Internet: www.nivus.de

Bezeichnung:	Portabler Durchflussmessumformer/-datenlogger mit internem Modem zur Datenfernübertragung über GPRS/UMTS/LTE NivuFlow Mobile/NivuLevel Mobile
<i>Description:</i>	<i>Portable flow measurement transmitter/data logger with internal modem for data transmission via GPRS/UMTS/LTE NivuFlow Mobile/NivuLevel Mobile</i>
<i>Désignation:</i>	<i>Débitmètre/enregistreur de données portable avec modem interne pour la transmission de données à distance via GPRS/UMTS/LTE NivuFlow Mobile/NivuLevel Mobile</i>
Typ / Type:	NFM0xxxG0 Gx

erklären wir in alleiniger Verantwortung, dass die auf dem Unionsmarkt ab dem Zeitpunkt der Unterzeichnung bereitgestellten Geräte die folgenden einschlägigen Harmonisierungsvorschriften der Union erfüllen:

we declare under our sole responsibility that the equipment made available on the Union market as of the date of signature of this document meets the standards of the following applicable Union harmonisation legislation:

nous déclarons, sous notre seule responsabilité, à la date de la présente signature, la conformité du produit pour le marché de l'Union, aux directives d'harmonisation de la législation au sein de l'Union:

- 2014/53/EU
- 2011/65/EU

Bei der Bewertung wurden folgende einschlägige harmonisierte Normen zugrunde gelegt bzw. wird die Konformität erklärt in Bezug auf die nachfolgend genannten anderen technischen Spezifikationen:

The evaluation assessed the following applicable harmonised standards or the conformity is declared in relation to other technical specifications listed below:

L'évaluation est effectuée à partir des normes harmonisées applicable ou la conformité est déclarée en relation aux autres spécifications techniques désignées ci-dessous:

- EN 61010-1:2010
- EN 61326-1:2013
- Draft ETSI EN 301 489-17 V3.1.1
- Draft ETSI EN 301 489-52 V1.1.2
- EN 301 893 V2.1.1 (WLAN)
- EN 301 511 V12.5.1 (GSM/2G)
- EN 301 908-2 V13.1.1 (UMTS/3G)
- EN 62311:2008
- EN 301 489-1 V2.2.3
- Draft ETSI EN 301 489-19 V2.1.1
- EN 300 328 V2.2.2 (WLAN)
- EN 300 440 V2.1.1 (WLAN)
- EN 301 908-1 V13.1.1 (UMTS/3G, LTE/4G)
- EN 301 908-13 V13.1.1 (LTE/4G)

Diese Erklärung wird verantwortlich für den Hersteller:

This declaration is submitted on behalf of the manufacturer:

Le fabricant assume la responsabilité de cette déclaration:

NIVUS GmbH
Im Täle 2
75031 Eppingen
Allemagne

abgegeben durch / *represented by / faite par:*

Marcus Fischer (Geschäftsführer / *Managing Director / Directeur général*)

Eppingen, den 06.07.2021

Gez. *Marcus Fischer*

DE / EN / FR

EU Konformitätserklärung

EU Declaration of Conformity

Déclaration de conformité UE



NIVUS GmbH
Im Täl 2
75031 Eppingen

Telefon: +49 07262 9191-0
Telefax: +49 07262 9191-999
E-Mail: info@nivus.com
Internet: www.nivus.de

Für das folgend bezeichnete Erzeugnis:

For the following product:

Le produit désigné ci-dessous:

Bezeichnung:	"Ex" Portabler Durchflussmessumformer/-datenlogger, mit internem Modem zur Datenfernübertragung über GPRS/UMTS/LTE NivuFlow Mobile / NivuLevel Mobile
<i>Description:</i>	<i>"Ex" Portable flow measurement transmitter/data logger, with internal modem for data transmission via GPRS/UMTS/LTE NivuFlow Mobile / NivuLevel Mobile</i>
<i>Désignation:</i>	<i>"Ex" Débitmètre/enregistreur de données portable avec modem interne pour la transmission de données à distance via GPRS/UMTS/LTE NivuFlow Mobile / NivuLevel Mobile</i>
Typ / Type:	NFM0xxxGE Ex

erklären wir in alleiniger Verantwortung, dass die auf dem Unionsmarkt ab dem Zeitpunkt der Unterzeichnung bereitgestellten Geräte die folgenden einschlägigen Harmonisierungsvorschriften der Union erfüllen:

we declare under our sole responsibility that the equipment made available on the Union market as of the date of signature of this document meets the standards of the following applicable Union harmonisation legislation:

nous déclarons, sous notre seule responsabilité, à la date de la présente signature, la conformité du produit pour le marché de l'Union, aux directives d'harmonisation de la législation au sein de l'Union:

- 2014/53/EU
- 2014/34/EU
- 2011/65/EU

Bei der Bewertung wurden folgende einschlägige harmonisierte Normen zugrunde gelegt bzw. wird die Konformität erklärt in Bezug auf die nachfolgend genannten anderen technischen Spezifikationen:

The evaluation assessed the following applicable harmonised standards or the conformity is declared in relation to other technical specifications listed below:

L'évaluation est effectuée à partir des normes harmonisées applicable ou la conformité est déclarée en relation aux autres spécifications techniques désignées ci-dessous:

- EN 61010-1:2010
- EN 301 489-1 V2.2.3
- Draft ETSI EN 301 489-19 V2.1.1
- EN 301 893 V2.1.1 (WLAN)
- EN 301 511 V12.5.1 (GSM/2G)
- EN 301 908-2 V13.1.1 (UMTS/3G)
- EN IEC 60079-7:2015/A1:2018
- EN 62311:2008
- Draft ETSI EN 301 489-17 V3.1.1
- Draft ETSI EN 301 489-52 V1.1.0
- EN 300 440 V2.1.1 (WLAN)
- EN 301 908-1 V13.1.1 (UMTS/3G, LTE/4G)
- EN 301 908-13 V13.1.1 (LTE/4G)
- EN 60079-11:2012
- EN 61326-1:2013
- EN 300 328 V2.2.2 (WLAN)
- EN IEC 60079-0:2018
- EN 60079-18:2015/A1:2017

Ex-Kennzeichnung / *Ex-designation / Marquage Ex :*

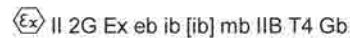

EU-Baumusterprüfbescheinigung / *EU-Type Examination Certificate / Attestation d'examen «UE» de type:*

TÜV 17 ATEX 196722 X issue: 01

Notifizierte Stelle (Kennnummer) / *Notified Body (Identif. No.) / Organisme notifié (N° d'identification)*

TÜV NORD CERT GmbH, Langemarckstraße 20, 45141 Essen, Germany

(0044)

Diese Erklärung wird verantwortlich für den Hersteller:

This declaration is submitted on behalf of the manufacturer:

Le fabricant assume la responsabilité de cette déclaration:

NIVUS GmbH
Im Täl 2
75031 Eppingen
Allemagne

abgegeben durch / *represented by / faite par:*

Marcus Fischer (Geschäftsführer / *Managing Director / Directeur général*)

Eppingen, den 06.07.2021

Gez. *Marcus Fischer*

DE / EN / FR

EU Konformitätserklärung

EU Declaration of Conformity

Déclaration de conformité UE

Für das folgend bezeichnete Erzeugnis:

For the following product:

Le produit désigné ci-dessous:



NIVUS GmbH
Im Täle 2
75031 Eppingen

Telefon: +49 07262 9191-0
Telefax: +49 07262 9191-999
E-Mail: info@nivus.com
Internet: www.nivus.de

Bezeichnung:	"Ex" Portabler Durchflussmessumformer/-datenlogger, mit internem Modem zur Datenfernübertragung über GPRS/UMTS/LTE NivuFlow Mobile / NivuLevel Mobile
<i>Description:</i>	<i>"Ex" Portable flow measurement transmitter/data logger, with internal modem for data transmission via GPRS/UMTS/LTE NivuFlow Mobile / NivuLevel Mobile</i>
<i>Désignation:</i>	<i>"Ex" Débitmètre/enregistreur de données portable avec modem interne pour la transmission de données à distance via GPRS/UMTS/LTE NivuFlow Mobile / NivuLevel Mobile</i>
Typ / Type:	NFM0xxxGE Gx

erklären wir in alleiniger Verantwortung, dass die auf dem Unionsmarkt ab dem Zeitpunkt der Unterzeichnung bereitgestellten Geräte die folgenden einschlägigen Harmonisierungsvorschriften der Union erfüllen:

we declare under our sole responsibility that the equipment made available on the Union market as of the date of signature of this document meets the standards of the following applicable Union harmonisation legislation:

nous déclarons, sous notre seule responsabilité, à la date de la présente signature, la conformité du produit pour le marché de l'Union, aux directives d'harmonisation de la législation au sein de l'Union:

- 2014/53/EU
- 2014/34/EU
- 2011/65/EU

Bei der Bewertung wurden folgende einschlägige harmonisierte Normen zugrunde gelegt bzw. wird die Konformität erklärt in Bezug auf die nachfolgend genannten anderen technischen Spezifikationen:

The evaluation assessed the following applicable harmonised standards or the conformity is declared in relation to other technical specifications listed below:

L'évaluation est effectuée à partir des normes harmonisées applicable ou la conformité est déclarée en relation aux autres spécifications techniques désignées ci-dessous:

- EN 61010-1:2010
- EN 301 489-1 V2.2.3
- Draft ETSI EN 301 489-19 V2.1.1
- EN 301 893 V2.1.1 (WLAN)
- EN 301 511 V12.5.1 (GSM/2G)
- EN 301 908-2 V13.1.1 (UMTS/3G)
- EN IEC 60079-0:2018
- EN 60079-18:2015/A1:2017
- EN 62311:2008
- Draft ETSI EN 301 489-17 V3.1.1
- Draft ETSI EN 301 489-52 V1.1.2
- EN 300 440 V2.1.1 (WLAN)
- EN 301 908-1 V13.1.1 (UMTS/3G, LTE/4G)
- EN 301 908-13 V13.1.1 (LTE/4G)
- EN IEC 60079-7:2015/A1:2018
- EN 61326-1:2013
- EN 300 328 V2.2.2 (WLAN)
- EN 60079-11:2012

Ex-Kennzeichnung / *Ex-designation / Marquage Ex :*

Ex II 2G Ex eb ib [ib] mb IIB T4 Gb

EU-Baumusterprüfbescheinigung / *EU-Type Examination Certificate / Attestation d'examen «UE» de type:*

TÜV 17 ATEX 196722 X issue: 01

Notifizierte Stelle (Kennnummer) / *Notified Body (Identif. No.) / Organisme notifié (N° d'identification)*

TÜV NORD CERT GmbH, Langemarckstraße 20, 45141 Essen, Germany

(0044)

Diese Erklärung wird verantwortlich für den Hersteller:

This declaration is submitted on behalf of the manufacturer:

Le fabricant assume la responsabilité de cette déclaration:

NIVUS GmbH
Im Täle 2
75031 Eppingen
Allemagne

abgegeben durch / *represented by / faite par:*

Marcus Fischer (Geschäftsführer / *Managing Director / Directeur général*)

Eppingen, den 06.07.2021

Gez. *Marcus Fischer*

DE / EN / FR

EU Konformitätserklärung

EU Declaration of Conformity

Déclaration de conformité UE



NIVUS GmbH
Im Täle 2
75031 Eppingen

Telefon: +49 07262 9191-0
Telefax: +49 07262 9191-999
E-Mail: info@nivus.com
Internet: www.nivus.de

Für das folgend bezeichnete Erzeugnis:

For the following product:

Le produit désigné ci-dessous:

Bezeichnung:	Ladeschale NFM
<i>Description:</i>	<i>charging station NFM</i>
<i>Désignation:</i>	<i>station de charge NFM</i>
Typ / Type:	NFM02 LADESCH

erklären wir in alleiniger Verantwortung, dass die auf dem Unionsmarkt ab dem Zeitpunkt der Unterzeichnung bereitgestellten Geräte die folgenden einschlägigen Harmonisierungsvorschriften der Union erfüllen:

we declare under our sole responsibility that the equipment made available on the Union market as of the date of signature of this document meets the standards of the following applicable Union harmonisation legislation:

nous déclarons, sous notre seule responsabilité, à la date de la présente signature, la conformité du produit pour le marché de l'Union, aux directives d'harmonisation de la législation au sein de l'Union:

- 2011/65/EU

Bei der Bewertung wurden folgende einschlägige harmonisierte Normen zugrunde gelegt bzw. wird die Konformität erklärt in Bezug die nachfolgend genannten anderen technischen Spezifikationen:

The evaluation assessed the following applicable harmonised standards or the conformity is declared in relation to other technical specifications listed below:

L'évaluation est effectuée à partir des normes harmonisées applicable ou la conformité est déclarée en relation aux autres spécifications techniques désignées ci-dessous:

- EN 50581:2012

Diese Erklärung wird verantwortlich für den Hersteller:

This declaration is submitted on behalf of the manufacturer:

Le fabricant assume la responsabilité de cette déclaration:

NIVUS GmbH
Im Täle 2
75031 Eppingen
Allemagne

abgegeben durch / *represented by / faite par:*

Marcus Fischer (Geschäftsführer / *Managing Director / Directeur général*)

Eppingen, den 08.02.2018

Gez. *Marcus Fischer*



Translation

(1) **EU-Type Examination Certificate**

- (2) Equipment and protective systems intended for use in potentially explosive atmospheres, **Directive 2014/34/EU**



- (3) **Certificate Number** TÜV 17 ATEX 196722 X **issue:** 01
- (4) for the product: Portable Measuring Transformer
NivuFlow Mobile Typ NFM-0xxx x E and
NivuLevel Mobile Typ NFM-0050 x E
- (5) of the manufacturer: NIVUS GmbH
- (6) Address: Im Täle 2
75031 Eppingen
- Order number: 8003009451
- Date of issue: 2019-10-28

- (7) The design of this product and any acceptable variation thereto are specified in the schedule to this EU-Type Examination Certificate and the documents therein referred to.
- (8) The TÜV NORD CERT GmbH, Notified Body No. 0044, in accordance with Article 17 of the Directive 2014/34/EU of the European Parliament and the Council of 26 February 2014, certifies that this product has been found to comply with the Essential Health and Safety Requirements relating to the design and construction of products intended for use in potentially explosive atmospheres given in Annex II to the Directive.
The examination and test results are recorded in the confidential ATEX Assessment Report No. 19 203 251874.
- (9) Compliance with the Essential Health and Safety Requirements has been assured by compliance with:
- EN 60079-0:2012+A11:2013 EN 60079-11:2012 EN 60079-7:2015
EN 60079-18:2015
- except in respect of those requirements listed at item 18 of the schedule.
- (10) If the sign "X" is placed after the certificate number, it indicates that the product is subject to the Specific Conditions for Use specified in the schedule to this certificate.
- (11) This EU-Type Examination Certificate relates only to the design, and construction of the specified product. Further requirements of the Directive apply to the manufacturing process and supply of this equipment. These are not covered by this certificate.
- (12) The marking of the product shall include the following:

 II 2 G Ex eb ib [ib] mb IIB T4 Gb

TÜV NORD CERT GmbH, Langemarckstraße 20, 45141 Essen, notified by the central office of the countries for safety engineering (ZLS), Ident. Nr. 0044, legal successor of the TÜV NORD CERT GmbH & Co. KG Ident. Nr. 0032

The head of the notified body

Rodér

Hanover office, Am TÜV 1, 30519 Hannover, Tel. +49 511 998-61455, Fax +49 511 998-61590

This certificate may only be reproduced without any change, schedule included.
Excerpts or changes shall be allowed by the TÜV NORD CERT GmbH



(13) **SCHEDULE**

(14) **EU-Type Examination Certificate No. TÜV 17 ATEX 196722 X issue 01**

(15) Description of product

Together with the belonging sensors, the Portable Measuring Transformer NivuFlow Mobile type NFM-0xxx x E and NivuLevel Mobile type NFM-0050 x E are used for the measurement of the flow speed and the flow level in partly or fully filled pipes and channels via supersonic technology. The Portable Measuring Transformer NivuFlow Mobile/NivuLevel Mobile type NFM... is operated stationary.

The permissible ambient temperature range is -15 °C ... +50 °C.

Electrical data

Supply voltage $U_n = 12 \text{ V d. c.}$
 (Internal plug connections) Powered with max. 2 x 12 V/15Ah VRLA-Pb-batteries;

External supply circuit in type of protection Intrinsic Safety Ex ib IIB
 (X1R [Uin], Only for connection to an intrinsically safe circuit
 X1B [GND]) Maximum values:
 $U_i = 14.5 \text{ V}$
 $I_i = 1.25 \text{ A}$
 $P_i = 18.1 \text{ W}$
 The effective internal capacitances and inductances are negligibly small.

1 wire circuit in type of protection Intrinsic Safety Ex ib IIB
 (CSM connector X10E [GND], Maximum values:
 X10F [1 wire];
 DSM connector X8E [GND], X8F [1 wire]) $U_o = 3.7 \text{ V}$
 $I_o = 57.3 \text{ mA}$
 $P_o = 53 \text{ mW}$
 Characteristic line: linear

Ex ib	IIB		
	max. permissible external inductance	65 mH	10 mH
max. permissible external capacitance	9.4 µF	21 µF	37 µF

5 V circuit in type of protection Intrinsic Safety Ex ib IIB
 (CSM connector X10E [GND], Maximum values:
 X10J [+5 V-Ex];
 DSM connector $U_o = 5.93 \text{ V}$
 X8E [GND], X8J [+5 V-Ex]) $I_o = 91.7 \text{ mA}$
 $P_o = 135.9 \text{ mW}$
 Characteristic line: linear

Ex ib	IIB		
	max. permissible external inductance	1 mH	0.2 mH
max. permissible external capacitance	14 µF	23 µF	30 µF



Schedule to EU-Type Examination Certificate No. TÜV 17 ATEX 196722 X issue 01

RS485 interface pressure, output in type of protection Intrinsic Safety Ex ib IIB
(CSM connector X10G [- RxTx],
X10H [+ RxTx])

Maximum values:

$$U_o = 3.7 \text{ V}$$

$$I_o = 95.1 \text{ mA}$$

$$P_o = 88 \text{ mW}$$

Characteristic line: linear

Ex ib	IIB		
max. permissible external inductance	25 mH	10 mH	1 mH
max. permissible external capacitance	11 μ F	18 μ F	36 μ F

RS485 interface pressure, input in type of protection Intrinsic Safety Ex ib IIB
(CSM connector X10G [- RxTx],
X10H [+ RxTx])

Only for connection to an intrinsically safe circuit

Maximum values:

$$U_i = 7.21 \text{ V}$$

$$I_i = 176 \text{ mA}$$

$$P_i = 317.2 \text{ mW}$$

The effective internal capacitances and inductances are negligibly small.

Radar sensor supply in type of protection Intrinsic Safety Ex ib IIB
(Connector X1A, X1B)

Maximum values:

$$U_o = 9.87 \text{ V}$$

$$I_o = 629 \text{ mA}$$

$$P_o = 6.21 \text{ W}$$

Characteristic line: rectangular

Ex ib	IIB		
max. permissible external inductance	0.2 mH	0.1 mH	0.05 mH
max. permissible external capacitance	5 μ F	8 μ F	11.9 μ F

RS485 interface, output in type of protection Intrinsic Safety Ex ib IIB
(Connector X1C, X1D)

Maximum values:

$$U_o = 3.7 \text{ V}$$

$$I_o = 95.1 \text{ mA}$$

$$P_o = 88 \text{ mW}$$

Characteristic line: linear

Ex ib	IIB		
max. permissible external inductance	25 mH	10 mH	1 mH
max. permissible external capacitance	11 μ F	18 μ F	36 μ F



Schedule to EU-Type Examination Certificate No. TÜV 17 ATEX 196722 X issue 01

RS485 interface, input in type of protection Intrinsic Safety Ex ib IIB
 (Connector X1C, X1D) Only for connection to an intrinsically safe circuit
 Maximum values:
 $U_i = 10.21 \text{ V}$
 $I_i = 248.8 \text{ mA}$
 $P_i = 633.8 \text{ mW}$
 The effective internal capacitances and inductances are negligibly small.

Analogue input no. 1 /2 in type of protection Intrinsic Safety Ex ib IIB
 (Connector X1G, X1F; X1H, X1J) Maximum values:
 NivuLevel Mobile type NFM-0050 x E: $U_o = 22.2 \text{ V}$
 Connector X7C, X7E; X7B, X7D) $I_o = 33 \text{ mA}$
 $R = 48 \text{ } \Omega$
 $P_o = 624 \text{ mW}$
 Characteristic line: trapezoidal

Ex ib	IIB		
max. permissible external inductance	20 mH	1 mH	0.1 mH
max. permissible external capacitance	0.52 μF	0.56 μF	1 μF

Analogue input no. 3 in type of protection Intrinsic Safety Ex ib IIB
 (Connector X1K, X1M) Maximum values:
 $U_o = 3.7 \text{ V}$
 $I_o = <1 \text{ mA}$
 $P_o = <1 \text{ mW}$
 Characteristic line: linear

Ex ib	IIB		
max. permissible external inductance	100 mH	10 mH	1 mH
max. permissible external capacitance	19 μF	24 μF	38 μF

Analogue input no. 3 in type of protection Intrinsic Safety Ex ib IIB
 (Connector X1K, X1M) Only for connection to an intrinsically safe circuit
 Maximum values:
 $U_i = 5.53 \text{ V}$
 $I_i = 33.5 \text{ mA}$
 $P_i = 185.4 \text{ mW}$
 The effective internal capacitances and inductances are negligibly small.



Schedule to EU-Type Examination Certificate No. TÜV 17 ATEX 196722 X issue 01

Analogue output in type of protection Intrinsic Safety Ex ib IIB
(Connector X1L, X1M) Maximum values:
 $U_o = 15.78 \text{ V}$
 $I_o = 177.4 \text{ mA}$
 $P_o = 700 \text{ mW}$
Characteristic line: linear

	Ex ib		IIB	
	max. permissible external inductance	5.5 mH	1 mH	0.1 mH
max. permissible external capacitance	1 μF	2.4 μF	2.6 μF	

Digital input in type of protection Intrinsic Safety Ex ib IIB
(Connector X1N, X1P) Maximum values:
 $U_o = 3.7 \text{ V}$
 $I_o = < 1 \text{ mA}$
 $P_o = < 1 \text{ mW}$
Characteristic line: linear

	Ex ib		IIB	
	max. permissible external inductance	100 mH	1 mH	0.1 mH
max. permissible external capacitance	19 μF	38 μF	81 μF	

Digital input in type of protection Intrinsic Safety Ex ib IIB
(Connector X1N, X1P) Only for connection to an intrinsically safe circuit
Maximum values:
 $U_i = 19.69 \text{ V}$
 $I_i = 4.23 \text{ mA}$
 $P_i = 83.3 \text{ mW}$
The effective internal capacitances and inductances are negligibly small.

Piezo circuits in type of protection Intrinsic Safety Ex ib IIB
(CSM connector X10 A/B and C/D, Only for connection
DSM connector X8 A/B and C/D) to the belonging sensors of the manufacturer
Max. output energy: 146 μJ

Relay output in type of protection Intrinsic Safety Ex ib IIB
(Connector X1S, X1T, X1U) Only for connection to an intrinsically safe circuit
Maximum values:
 $U_i = 26 \text{ V}$
 $I_i = 100 \text{ mA}$
 $P_i = 2.6 \text{ W}$
The effective internal capacitances and inductances are negligibly small.



Schedule to EU-Type Examination Certificate No. TÜV 17 ATEX 196722 X issue 01

SIM-card circuit in type of protection Intrinsic Safety Ex ib IIB
 (SIM-CARD connector) Maximum values:
 $U_o = 4.5 \text{ V}$
 $I_o = 283 \text{ mA}$
 $P_o = 319 \text{ mW}$
 Characteristic line: linear

Ex ib	IIB		
	max. permissible external inductance	1 mH	0.1 mH
max. permissible external capacitance	21 μF	51 μF	120 μF

The rules for interconnection of intrinsically safe circuits have to be observed.

(16) Drawings and documents are listed in the ATEX Assessment Report No. 19 203 251874.

(17) Specific Conditions for Use

1. Electrostatic charge has to be avoided for all housing parts and the interlock; the manual of the manufacturer has to be observed.
2. Charging of the supply batteries is only permitted outside of the explosion hazardous area with the charger of the manufacturer or with a separately certified charger (intrinsically safe charge circuit); the manual of the manufacturer has to be observed.
3. Change of the supply batteries / backup battery is only permitted outside of the explosion hazardous area.
4. Only permissible batteries according to the manufacturer's operating instructions are allowed to be used.
5. The memory stick is only permitted to be used outside of the explosion hazardous area at the USB port.
6. The change of the SIM card is only permitted outside of the explosion hazardous area. See "Electrical data" for operation in the explosion hazardous area.
7. Operation is only allowed in vertical position (plug-connectors downwards).
8. The housing has to be additionally secured by an interlock provided by the manufacturer.
9. The battery in the right-hand housing part (connections MP1/MP2) is not allowed to be connected, if the external power supply is used.
10. The connections at X8 are only permissible for use of the manufacturer for firmware-updates in the safe area.



(18) Essential Health and Safety Requirements

no additional ones

- End of Certificate -

		IECEX Certificate of Conformity	
INTERNATIONAL ELECTROTECHNICAL COMMISSION IEC Certification System for Explosive Atmospheres <small>for rules and details of the IECEx Scheme visit www.iecex.com</small>			
Certificate No.:	IECEX TUN 18.0008X	Page 1 of 4	<u>Certificate history:</u> Issue 0 (2018-07-27)
Status:	Current	Issue No: 1	
Date of Issue:	2019-11-13		
Applicant:	NIVUS GmbH Im Tälle 2, 75031 Eppingen Germany		
Equipment:	Portable Measuring Transformer NivuFlow Mobile type NFM-0xxx x E, NivuLevel Mobile type NFM-0050 x E		
Optional accessory:			
Type of Protection:	Increased safety "e", Intrinsic safety "i", encapsulation "m"		
Marking:	Ex eb Ib [ib] mb IIB T4 Gb		
Approved for issue on behalf of the IECEx: Certification Body:	Christian Roder		
Position:	Head of the IECEx Certification Body		
Signature: (for printed version)			
Date:	2019-11-13		
<ol style="list-style-type: none">1. This certificate and schedule may only be reproduced in full.2. This certificate is not transferable and remains the property of the issuing body.3. The Status and authenticity of this certificate may be verified by visiting www.iecex.com or use of this QR Code.			
Certificate issued by: TÜV NORD CERT GmbH Hanover Office Am TÜV 1, 30519 Hannover Germany			

		<h2>IECEX Certificate of Conformity</h2>	
Certificate No.:	IECEX TUN 18.0008X	Page 2 of 4	
Date of issue:	2019-11-13	Issue No: 1	
Manufacturer:	NIVUS GmbH Im Täle 2, 75031 Eppingen Germany		
Additional manufacturing locations:			
<p>This certificate is issued as verification that a sample(s), representative of production, was assessed and tested and found to comply with the IEC Standard list below and that the manufacturer's quality system, relating to the Ex products covered by this certificate, was assessed and found to comply with the IECEx Quality system requirements. This certificate is granted subject to the conditions as set out in IECEx Scheme Rules, IECEx 02 and Operational Documents as amended</p>			
<p>STANDARDS : The equipment and any acceptable variations to it specified in the schedule of this certificate and the identified documents, was found to comply with the following standards</p>			
IEC 60079-0:2011 Edition:6.0	Explosive atmospheres - Part 0: General requirements		
IEC 60079-11:2011 Edition:6.0	Explosive atmospheres - Part 11: Equipment protection by intrinsic safety "i"		
IEC 60079-18:2014 Edition:4.0	Explosive atmospheres – Part 18: Equipment protection by encapsulation "m"		
IEC 60079-7:2015 Edition:5.0	Explosive atmospheres – Part 7: Equipment protection by increased safety "e"		
<p>This Certificate does not indicate compliance with safety and performance requirements other than those expressly included in the Standards listed above.</p>			
<p>TEST & ASSESSMENT REPORTS: A sample(s) of the equipment listed has successfully met the examination and test requirements as recorded in:</p>			
Test Report:	DE/TUN/EXTR18.0013/00		
Quality Assessment Report:	DE/TUN/QAR13.0011/05		

		IECEX Certificate of Conformity
Certificate No.:	IECEX TUN 18.0008X	Page 3 of 4
Date of issue:	2019-11-13	Issue No: 1
EQUIPMENT: Equipment and systems covered by this Certificate are as follows:		
Together with the belonging sensors, the "Portable Measuring Transformer"		
NivuFlow Mobile type NFM-0xxx x E and		
NivuLevel Mobile type NFM-0050 x E		
are used for the measurement of the flow speed and the flow level in partly or fully filled pipes and channels via supersonic technology.		
The Portable Measuring Transformer type NivuFlow Mobile NFM is operated stationary.		
The permissible ambient temperature range is -15 °C ... +50 °C.		
For further information, see attachment.		
SPECIFIC CONDITIONS OF USE: YES as shown below:		
<ol style="list-style-type: none">1. Electrostatic charge has to be avoided for all housing parts and the interlock; the manual of the manufacturer has to be observed.2. Charging of the supply batteries is only permitted outside of the explosion hazardous area with the charger of the manufacturer or with a separately certified charger (intrinsically safe charge circuit); the manual of the manufacturer has to be observed.3. Change of the supply batteries / backup battery is only permitted outside of the explosion hazardous area.4. Only permissible batteries according to the manufacturer's operating instructions are allowed to be used.5. The memory stick is only permitted to be used outside of the explosion hazardous area at the USB port.6. The change of the SIM card is only permitted outside of the explosion hazardous area. See "Electrical data" for operation in the explosion hazardous area.7. Operation is only allowed in vertical position (plug-connectors downwards).8. The housing has to be additionally secured by an interlock provided by the manufacturer.9. The battery in the right-hand housing part (connections MP1/MP2) is not allowed to be connected, if the external power supply is used.10. The connections at X8 are only permissible for use of the manufacturer for firmware-updates in the safe area.		

	IECEX Certificate of Conformity	
Certificate No.:	IECEX TUN 18.0008X	Page 4 of 4
Date of issue:	2019-11-13	Issue No: 1
DETAILS OF CERTIFICATE CHANGES (for issues 1 and above)		
-Mechanical changes		
-Layout changes		
-Electrical data partly changed		
-Special Conditions partly changed		
-New type with less components "NivuLevel Mobile type NFM-0050 x E"		
Annex:		
Attachment _issue 1_NivuFlow Mobile.pdf		

TÜV NORD CERT GmbH
Hannover Office
Am TÜV 1
30519 Hannover
Germany



Page 1 of 5
Attachment to IECEx TUN 18.0008 X Issue No.: 01

Product:

Together with the belonging sensors, the Portable Measuring Transformer NivuFlow Mobile type NFM-0xxx x E and NivuLevel Mobile type NFM-0050 x E are used for the measurement of the flow speed and the flow level in partly or fully filled pipes and channels via supersonic technology. The Portable Measuring Transformer NivuFlow Mobile/NivuLevel Mobile type NFM... is operated stationary.

The permissible ambient temperature range is -15 °C ... +50 °C.

Electrical data

Supply voltage $U_n = 12 \text{ V d. c.}$
(Internal plug connections) Powered with max. 2 x 12 V/15Ah VRLA-Pb-batteries;

External supply circuit in type of protection Intrinsic Safety Ex ib IIB
(X1R [Uin],
X1B [GND]) Only for connection to an intrinsically safe circuit.
Maximum values:
 $U_i = 14.5 \text{ V}$
 $I_i = 1.25 \text{ A}$
 $P_i = 18.1 \text{ W}$
The effective internal capacitances and inductances are negligibly small.

1 wire circuit in type of protection Intrinsic Safety Ex ib IIB
(CSM connector X10E [GND],
X10F [1 wire];
DSM connector X8E [GND], X8F [1 wire])
 $U_o = 3.7 \text{ V}$
 $I_o = 57.3 \text{ mA}$
 $P_o = 53 \text{ mW}$
Characteristic line: linear

	Ex ib			IIB		
max. permissible external inductance	65 mH	10 mH	1 mH			
max. permissible external capacitance	9.4 µF	21 µF	37 µF			

5 V circuit in type of protection Intrinsic Safety Ex ib IIB
(CSM connector X10E [GND],
X10J [+5 V-Ex];
DSM connector
X8E [GND], X8J [+5 V-Ex])
 $U_o = 5.93 \text{ V}$
 $I_o = 91.7 \text{ mA}$
 $P_o = 135.9 \text{ mW}$
Characteristic line: linear

	Ex ib			IIB		
max. permissible external inductance	1 mH	0.2 mH	0.1 mH			
max. permissible external capacitance	14 µF	23 µF	30 µF			

TÜV NORD CERT GmbH
 Hannover Office
 Am TÜV 1
 30519 Hannover
 Germany



Page 2 of 5
 Attachment to IECEx TUN 18.0008 X Issue No.: 01

RS485 interface pressure, output in type of protection Intrinsic Safety Ex ib IIB
 (CSM connector X10G [- RxTx], X10H [+ RxTx]) Maximum values:

$U_o = 3.7 \text{ V}$
 $I_o = 95.1 \text{ mA}$
 $P_o = 88 \text{ mW}$
 Characteristic line: linear

Ex ib	IIB		
max. permissible external inductance	25 mH	10 mH	1 mH
max. permissible external capacitance	11 μF	18 μF	36 μF

RS485 interface pressure, input in type of protection Intrinsic Safety Ex ib IIB
 (CSM connector X10G [- RxTx], X10H [+ RxTx]) Only for connection to an intrinsically safe circuit
 Maximum values:

$U_i = 7.21 \text{ V}$
 $I_i = 176 \text{ mA}$
 $P_i = 317.2 \text{ mW}$
 The effective internal capacitances and inductances are negligibly small.

Radar sensor supply in type of protection Intrinsic Safety Ex ib IIB
 (Connector X1A, X1B) Maximum values:

$U_o = 9.87 \text{ V}$
 $I_o = 629 \text{ mA}$
 $P_o = 6.21 \text{ W}$
 Characteristic line: rectangular

Ex ib	IIB		
max. permissible external inductance	0.2 mH	0.1 mH	0.05 mH
max. permissible external capacitance	5 μF	8 μF	11.9 μF

RS485 interface, output in type of protection Intrinsic Safety Ex ib IIB
 (Connector X1C, X1D) Maximum values:

$U_o = 3.7 \text{ V}$
 $I_o = 95.1 \text{ mA}$
 $P_o = 88 \text{ mW}$
 Characteristic line: linear

Ex ib	IIB		
max. permissible external inductance	25 mH	10 mH	1 mH
max. permissible external capacitance	11 μF	18 μF	36 μF

TÜV NORD CERT GmbH
Hannover Office
Am TÜV 1
30519 Hannover
Germany



Page 3 of 5
Attachment to IECEx TUN 18.0008 X issue No.: 01

RS485 interface, input in type of protection Intrinsic Safety Ex ib IIB
(Connector X1C, X1D) Only for connection to an intrinsically safe circuit
Maximum values:
 $U_i = 10.21 \text{ V}$
 $I_i = 248.8 \text{ mA}$
 $P_i = 633.8 \text{ mW}$
The effective internal capacitances and inductances are negligibly small.

Analogue input no. 1 /2 in type of protection Intrinsic Safety Ex ib IIB
(Connector X1G, X1F; X1H, X1J) Maximum values:
NivuLevel Mobile type NFM-0050 x E: $U_o = 22.2 \text{ V}$
Connector X7C, X7E; X7B, X7D) $I_o = 33 \text{ mA}$
 $R = 48 \text{ } \Omega$
 $P_o = 624 \text{ mW}$
Characteristic line: trapezoidal

Ex ib	IIB		
max. permissible external inductance	20 mH	1 mH	0.1 mH
max. permissible external capacitance	0.52 μF	0.56 μF	1 μF

Analogue input no. 3 in type of protection Intrinsic Safety Ex ib IIB
(Connector X1K, X1M) Maximum values:
 $U_o = 3.7 \text{ V}$
 $I_o = <1 \text{ mA}$
 $P_o = <1 \text{ mW}$
Characteristic line: linear

Ex ib	IIB		
max. permissible external inductance	100 mH	10 mH	1 mH
max. permissible external capacitance	19 μF	24 μF	38 μF

Analogue input no. 3 in type of protection Intrinsic Safety Ex ib IIB
(Connector X1K, X1M) Only for connection to an intrinsically safe circuit
Maximum values:
 $U_i = 5.53 \text{ V}$
 $I_i = 33.5 \text{ mA}$
 $P_i = 185.4 \text{ mW}$
The effective internal capacitances and inductances are negligibly small.

TÜV NORD CERT GmbH
 Hannover Office
 Am TÜV 1
 30519 Hannover
 Germany



Page 4 of 5
 Attachment to IECEx TUN 18.0008 X Issue No.: 01

Analogue output in type of protection Intrinsic Safety Ex ib IIB
 (Connector X1L, X1M) Maximum values:
 $U_o = 15.78 \text{ V}$
 $I_o = 177.4 \text{ mA}$
 $P_o = 700 \text{ mW}$
 Characteristic line: linear

Ex ib	IIB		
max. permissible external inductance	5.5 mH	1 mH	0.1 mH
max. permissible external capacitance	1 μF	2.4 μF	2.6 μF

Digital input in type of protection Intrinsic Safety Ex ib IIB
 (Connector X1N, X1P) Maximum values:
 $U_o = 3.7 \text{ V}$
 $I_o = < 1 \text{ mA}$
 $P_o = < 1 \text{ mW}$
 Characteristic line: linear

Ex ib	IIB		
max. permissible external inductance	100 mH	1 mH	0.1 mH
max. permissible external capacitance	19 μF	38 μF	81 μF

Digital input in type of protection Intrinsic Safety Ex ib IIB
 (Connector X1N, X1P) Only for connection to an intrinsically safe circuit.
 Maximum values:
 $U_i = 19.69 \text{ V}$
 $I_i = 4.23 \text{ mA}$
 $P_i = 83.3 \text{ mW}$
 The effective internal capacitances and inductances are negligibly small.

Piezo circuits in type of protection Intrinsic Safety Ex ib IIB
 (CSM connector X10 A/B and C/D,
 DSM connector X8 A/B and C/D) Only for connection
 to the belonging sensors of the manufacturer
 Max. output energy: 146 μJ

Relay output in type of protection Intrinsic Safety Ex ib IIB
 (Connector X1S, X1T, X1U) Only for connection to an intrinsically safe circuit.
 Maximum values:
 $U_i = 26 \text{ V}$
 $I_i = 100 \text{ mA}$
 $P_i = 2.6 \text{ W}$
 The effective internal capacitances and inductances are negligibly small.

TÜV NORD CERT GmbH
Hannover Office
Am TÜV 1
30519 Hannover
Germany



Page 5 of 5
Attachment to IECEx TUN 18.0008 X issue No.: 01

SIM-card circuit in type of protection Intrinsic Safety Ex ib IIB (SIM-CARD connector)													
Maximum values:													
$U_o = 4.5 \text{ V}$													
$I_o = 283 \text{ mA}$													
$P_o = 319 \text{ mW}$													
Characteristic line: linear													
	<table border="1"> <thead> <tr> <th>Ex ib</th> <th colspan="3">IIB</th> </tr> </thead> <tbody> <tr> <td>max. permissible external inductance</td> <td>1 mH</td> <td>0.1 mH</td> <td>0.02 mH</td> </tr> <tr> <td>max. permissible external capacitance</td> <td>21 μF</td> <td>51 μF</td> <td>120 μF</td> </tr> </tbody> </table>	Ex ib	IIB			max. permissible external inductance	1 mH	0.1 mH	0.02 mH	max. permissible external capacitance	21 μF	51 μF	120 μF
Ex ib	IIB												
max. permissible external inductance	1 mH	0.1 mH	0.02 mH										
max. permissible external capacitance	21 μF	51 μF	120 μF										

The rules for interconnection of intrinsically safe circuits have to be observed.

Special Conditions for Safe Use:

1. Electrostatic charge has to be avoided for all housing parts and the interlock; the manual of the manufacturer has to be observed.
2. Charging of the supply batteries is only permitted outside of the explosion hazardous area with the charger of the manufacturer or with a separately certified charger (intrinsically safe charge circuit); the manual of the manufacturer has to be observed.
3. Change of the supply batteries / backup battery is only permitted outside of the explosion hazardous area.
4. Only permissible batteries according to the manufacturer's operating instructions are allowed to be used.
5. The memory stick is only permitted to be used outside of the explosion hazardous area at the USB port.
6. The change of the SIM card is only permitted outside of the explosion hazardous area. See "Electrical data" for operation in the explosion hazardous area.
7. Operation is only allowed in vertical position (plug-connectors downwards).
8. The housing has to be additionally secured by an interlock provided by the manufacturer.
9. The battery in the right-hand housing part (connections MP1/MP2) is not allowed to be connected, if the external power supply is used.
10. The connections at X8 are only permissible for use of the manufacturer for firmware-updates in the safe area.